

ETSI EN 303 883-1 V1.2.1 (2021-02)



**Short Range Devices (SRD) and  
Ultra Wide Band (UWB);  
Part 1: Measurement techniques  
for transmitter requirements**

---

**Reference**REN/ERM-TGUWB-149-1

---

---

**Keywords**SRD, testing, UWB

---

**ETSI**

650 Route des Lucioles  
F-06921 Sophia Antipolis Cedex - FRANCE

---

Tel.: +33 4 92 94 42 00 Fax: +33 4 93 65 47 16

Siret N° 348 623 562 00017 - NAF 742 C  
Association à but non lucratif enregistrée à la  
Sous-Préfecture de Grasse (06) N° 7803/88

---

**Important notice**

---

The present document can be downloaded from:

<http://www.etsi.org/standards-search>

The present document may be made available in electronic versions and/or in print. The content of any electronic and/or print versions of the present document shall not be modified without the prior written authorization of ETSI. In case of any existing or perceived difference in contents between such versions and/or in print, the prevailing version of an ETSI deliverable is the one made publicly available in PDF format at [www.etsi.org/deliver](http://www.etsi.org/deliver).

Users of the present document should be aware that the document may be subject to revision or change of status.

Information on the current status of this and other ETSI documents is available at

<https://portal.etsi.org/TB/ETSIDeliverableStatus.aspx>

If you find errors in the present document, please send your comment to one of the following services:

<https://portal.etsi.org/People/CommitteeSupportStaff.aspx>

---

**Copyright Notification**

---

No part may be reproduced or utilized in any form or by any means, electronic or mechanical, including photocopying and microfilm except as authorized by written permission of ETSI.

The content of the PDF version shall not be modified without the written authorization of ETSI.

The copyright and the foregoing restriction extend to reproduction in all media.

© ETSI 2021.

All rights reserved.

**DECT™**, **PLUGTESTS™**, **UMTS™** and the ETSI logo are trademarks of ETSI registered for the benefit of its Members.

**3GPP™** and **LTE™** are trademarks of ETSI registered for the benefit of its Members and of the 3GPP Organizational Partners.

**oneM2M™** logo is a trademark of ETSI registered for the benefit of its Members and of the oneM2M Partners.

**GSM®** and the GSM logo are trademarks registered and owned by the GSM Association.

# Contents

Intellectual Property Rights .....	8
Foreword.....	8
Modal verbs terminology.....	8
Introduction .....	9
1 Scope .....	10
2 References .....	10
2.1 Normative references .....	10
2.2 Informative references.....	10
3 Definition of terms, symbols and abbreviations.....	12
3.1 Terms.....	12
3.2 Symbols.....	15
3.3 Abbreviations .....	16
4 Overview .....	17
4.1 Information.....	17
4.2 Basic information about UWB .....	17
5 TX requirements.....	18
5.1 General .....	18
5.1.1 General Guidance on TX measurements .....	18
5.1.2 Emission Concept .....	18
5.1.2.1 General .....	18
5.1.2.2 UWB - EUT .....	18
5.2 Operating Frequency Range (OFR).....	19
5.2.1 Definition.....	19
5.2.2 Conformance Test.....	20
5.3 Radiated Power (RP).....	20
5.3.1 Mean e.i.r.p. ....	20
5.3.1.1 Description .....	20
5.3.1.2 Conformance.....	20
5.3.1.3 Method with a Spectrum Analyser.....	20
5.3.1.4 Method with an RMS Power Meter .....	21
5.3.1.5 Method with a Peak Power Meter .....	22
5.3.2 Mean e.i.r.p. Spectral Density.....	22
5.3.2.1 Description .....	22
5.3.2.2 Guidance for Mean e.i.r.p. Spectral Density Conformance Tests .....	22
5.3.2.3 Mean e.i.r.p. Spectral Density, averaged over 1 ms .....	22
5.3.2.4 Mean e.i.r.p. Spectral Density, known signal repetition time, averaged over 1 ms.....	24
5.3.2.5 Mean e.i.r.p. Spectral Density, known signal repetition time, averaged over signal repetition time .....	25
5.3.3 Peak e.i.r.p. ....	26
5.3.3.1 Description .....	26
5.3.3.2 Conformance.....	26
5.3.3.3 Peak e.i.r.p.; Method with a Spectrum Analyser.....	27
5.3.3.4 Peak e.i.r.p. Method with an RMS Power Meter.....	27
5.3.3.5 Peak e.i.r.p. method with a Peak Power Meter.....	27
5.3.4 Peak e.i.r.p. Spectral Density .....	28
5.3.4.1 Description .....	28
5.3.4.2 Peak e.i.r.p. Spectral Density, General Method .....	28
5.3.4.3 Peak e.i.r.p. Spectral Density, Sparse Spectral Line Method .....	30
5.4 Other Emissions (OE) .....	30
5.5 TX Unwanted Emissions (TXUE).....	31
5.5.1 Description.....	31
5.5.2 Limits for the TX Unwanted Emission .....	32
5.5.3 General for Conformance Test for TX Unwanted Emission.....	32
5.5.3.1 General .....	32

5.5.3.2	Step 1: Measurement with Peak Detector .....	32
5.5.3.3	Step 2: RMS Measurement .....	33
5.6	Total Radiated Power (TRP) .....	34
5.6.1	Description.....	34
5.6.2	Conformance Test.....	35
5.6.2.1	General .....	35
5.6.2.2	TRP Conformance Assessment in steps: .....	35
5.7	Indirect Emissions .....	36
5.7.1	Description.....	36
5.7.2	Guidance for Conformance Test.....	40
5.8	Transmit Power Control .....	40
5.8.1	Description.....	40
5.8.2	Guidance for Conformance Test.....	40
5.9	Detect and Avoid.....	41
5.9.1	Description.....	41
5.9.2	Limits.....	41
5.9.2.1	DAA Parameters .....	41
5.9.2.2	DAA NIM parameters.....	42
5.9.2.3	DAA test parameters .....	42
5.9.3	Conformance Test.....	42
5.9.3.1	Introduction .....	42
5.9.3.2	Initial Start-Up Test.....	44
5.9.3.2.1	Start-up Procedure .....	44
5.9.3.2.2	Test without a victim test signal during the <i>Minimum Initial Channel Availability Check</i> <i>Time, T<sub>avail_time_min</sub></i> .....	44
5.9.3.2.3	Test with a victim test signal at the beginning of the <i>Minimum Initial Channel Availability</i> <i>Check Time, T<sub>avail_time_min</sub></i> .....	45
5.9.3.2.4	Test with a victim test signal at the end of the <i>Minimum Initial Channel Availability Check</i> <i>Time, T<sub>avail_time_min</sub></i> .....	46
5.9.3.3	In-Operation Test .....	47
5.9.3.3.1	General Points for In-Operation Test .....	47
5.9.3.3.2	In-Operation Test Procedure .....	48
5.10	Listen Before Talk (LBT).....	49
5.10.1	Description.....	49
5.10.2	Limits.....	50
5.10.3	Conformance.....	51
5.10.3.1	Measurement Procedure.....	51
5.10.3.2	Test Set-Up .....	51
5.10.3.3	Test Signal Definition for LBT Mechanism in Band 2 and 3 .....	52
5.10.3.3.1	Band 2: Mobile Satellite Service (MSS) Test Signal.....	52
5.10.3.3.2	Band 3: Land Mobile Service Test Signal .....	52
5.10.3.4	Test Signal Definition for LBT Mechanism in Band 1 and 4 .....	52
5.10.3.5	Conformance Test to Measure the Timing for LBT within bands 1 and 4.....	54
5.11	Duty Cycle.....	55
5.11.1	Description.....	55
5.11.2	Conformance.....	56
5.11.2.1	Duty Cycle, Spectrum Analyser Method .....	56
5.11.2.2	Duty Cycle, Oscilloscope Method .....	56
5.11.2.3	Duty Cycle Measurement Methods for FMCW, stepped-frequency and Pulsed Systems .....	58
5.11.2.3.1	General .....	58
5.11.2.3.2	Method 1: Diode Power Detector.....	58
5.11.2.3.3	Method 2: Spectrum Analyzer.....	59
5.11.2.3.4	Method 3: Synchronized Spectrum Analysers.....	60
5.11.2.4	Duty Cycle Measurement Methods within a frequency band for FMCW and stepped-frequency systems.....	61
5.11.2.4.1	General .....	61
5.11.2.4.2	Synchronized Spectrum Analysers.....	61
<b>Annex A (normative):</b>	<b>General Considerations and test conditions.....</b>	<b>64</b>
A.1	Overview .....	64
A.2	Product Information .....	64

A.3	Guidance on EUT Modulation for Testing.....	65
A.4	Requirements in Case of EUT with Scanning Antennas.....	65
A.4.1	Classification.....	65
A.4.2	Measurement of Fixed Beam EUT.....	65
A.4.3	Measurement of Constant Pattern EUT.....	65
A.4.4	Measurement of Variable Pattern EUT.....	66
A.5	Test Conditions, Power Supply and Ambient Temperatures .....	66
A.5.1	General.....	66
A.5.2	Power Sources.....	66
A.5.2.1	Power Sources for Stand-Alone Equipment.....	66
A.5.2.2	Power sources for plug-in radio devices.....	67
A.5.3	Normal and Extreme Test Conditions.....	67
A.5.3.1	Normal Test Conditions.....	67
A.5.3.1.1	Normal Temperature and Humidity.....	67
A.5.3.1.2	Normal Power Source.....	67
A.5.3.1.2.1	Mains Voltage.....	67
A.5.3.1.2.2	Lead-Acid Battery Power Sources used on Vehicles.....	67
A.5.3.1.2.3	Other Power Sources.....	67
A.5.3.2	Extreme Conditions.....	67
A.5.3.2.1	Extreme Temperatures.....	67
A.5.3.2.1.1	Procedure for Tests at Extreme Temperatures.....	67
A.5.3.2.1.2	Extreme Temperature Ranges.....	68
A.5.3.2.2	Extreme Test Source Voltages.....	68
A.5.3.2.2.1	Mains Voltage.....	68
A.5.3.2.2.2	Other Power Sources.....	68
A.5.3.2.3	Radio Transparent Temperature Chamber.....	68
A.5.3.2.4	Use of a Test Fixture.....	68
A.5.3.2.4.1	General.....	68
A.5.3.2.4.2	Characteristics.....	69
A.5.3.2.4.3	Validation of the Test Fixture in the Temperature Chamber.....	70
A.5.3.2.4.4	Use of the Test Fixture for Measurement in the Temperature Chamber.....	71
A.6	Choice of Equipment for Test Suites.....	71
A.6.1	Choice of Model.....	71
A.6.2	Presentation.....	71
A.7	Testing of Host Connected Equipment and Plug-In Radio Devices.....	71
A.7.1	General.....	71
A.7.2	The Use of a Host or Test Fixture for Testing Plug-In Radio Devices.....	72
A.8	Interpretation of the measurement results.....	72
A.8.1	General points on interpretation of the measurement results.....	72
A.8.2	Measurement uncertainty is equal to or less than maximum acceptable uncertainty.....	73
A.8.3	Measurement uncertainty is greater than maximum acceptable uncertainty.....	73
<b>Annex B (normative): Test setups .....</b>		<b>74</b>
B.1	Introduction.....	74
B.2	Radiated measurements.....	74
B.2.1	General.....	74
B.2.2	Test Sites and General Arrangements for Measurements Involving the Use of Radiated Fields.....	74
B.2.2.1	General.....	74
B.2.2.2	Anechoic Chamber.....	75
B.2.2.3	Anechoic Chamber with a Conductive Ground Plane.....	76
B.2.2.4	Open Area Test Site (OATS).....	77
B.2.2.5	Test Antenna.....	78
B.2.2.6	Substitution Antenna.....	78
B.2.2.7	Measuring Antenna.....	79
B.2.2.8	Minimum Requirements for Test Sites for Measurements above 18 GHz.....	79
B.2.3	Guidance on the Use of a Radiation Test Site.....	80
B.2.3.1	General on Guidance on the Use of a Radiation Test Site.....	80

B.2.3.2	Verification of the Test Site .....	80
B.2.3.3	Preparation of the EUT .....	80
B.2.3.4	Power Supplies to the EUT .....	81
B.2.3.5	Range Length .....	81
B.2.3.5.1	General .....	81
B.2.3.5.2	Practical Test Distances for Accurate Measurements .....	81
B.2.3.6	Site Preparation .....	82
B.2.4	Coupling of Signals .....	82
B.2.4.1	General .....	82
B.2.4.2	Data Signals .....	83
B.2.5	Standard Radiated Test Methods .....	83
B.2.5.0	Initial Measurement Steps .....	83
B.2.5.1	General Information on Test Methods .....	83
B.2.5.2	Calibrated Setup .....	83
B.2.5.3	Substitution Method .....	84
B.2.6	Standard calibration method .....	84
B.3	Conducted Measurements .....	86
B.4	Detailed Information to Standard Test Methods .....	87
B.4.1	Spherical Scan with Automatic Test Antenna Placement .....	87
B.4.1.1	General .....	87
B.4.1.2	Calibrated Setup .....	88
B.4.1.3	Substitution Method .....	89
B.4.1.4	Spherical Scan with Rotating EUT .....	89
B.4.1.4.1	General .....	89
B.4.1.4.2	Calibrated Setup .....	90
B.4.1.4.3	Substitution Method .....	90
B.4.1.5	Spherical Scan Other Methods .....	91
<b>Annex C (normative):</b>	<b>Signal Repetition Time .....</b>	<b>92</b>
C.1	Definitions .....	92
C.2	Signal Types .....	92
C.2.1	Pulsed signals .....	92
C.2.2	FMCW signals, Stepped/Hopping Frequency Signals and Similar .....	93
C.3	Measurement procedure for time parameters .....	94
<b>Annex D (normative):</b>	<b>All Emission Measurement .....</b>	<b>95</b>
D.1	General .....	95
D.2	First step .....	95
D.3	Second step .....	97
<b>Annex E (normative):</b>	<b>Guidance for a pre-scan of EUT operating frequency range(s) .....</b>	<b>98</b>
<b>Annex F (informative):</b>	<b>Measurement of peak e.i.r.p. and mean (average) e.i.r.p. of constant duty cycle wideband pulsed signals .....</b>	<b>99</b>
F.1	General .....	99
F.2	Exemplary measurement of pulse signals .....	99
F.3	Mean e.i.r.p. measurements .....	100
F.3.1	General .....	100
F.3.2	Method I: Zero span mode .....	100
F.3.3	Method II: Channel power measurement .....	101
F.3.4	Method III: Average power meters .....	102
F.4	Peak e.i.r.p. measurements .....	102
F.4.1	General .....	102
F.4.2	Method I: Zero span mode - direct measurement .....	102
F.4.3	Method II: Peak e.i.r.p. calculation .....	103

F.5	Max and mean PSD .....	104
<b>Annex G (informative):</b>	<b>Change History .....</b>	<b>106</b>
History .....		107

---

## Intellectual Property Rights

### Essential patents

IPRs essential or potentially essential to normative deliverables may have been declared to ETSI. The information pertaining to these essential IPRs, if any, is publicly available for **ETSI members and non-members**, and can be found in ETSI SR 000 314: "*Intellectual Property Rights (IPRs); Essential, or potentially Essential, IPRs notified to ETSI in respect of ETSI standards*", which is available from the ETSI Secretariat. Latest updates are available on the ETSI Web server (<https://ipr.etsi.org/>).

Pursuant to the ETSI IPR Policy, no investigation, including IPR searches, has been carried out by ETSI. No guarantee can be given as to the existence of other IPRs not referenced in ETSI SR 000 314 (or the updates on the ETSI Web server) which are, or may be, or may become, essential to the present document.

### Trademarks

The present document may include trademarks and/or tradenames which are asserted and/or registered by their owners. ETSI claims no ownership of these except for any which are indicated as being the property of ETSI, and conveys no right to use or reproduce any trademark and/or tradename. Mention of those trademarks in the present document does not constitute an endorsement by ETSI of products, services or organizations associated with those trademarks.

---

## Foreword

This European Standard (EN) has been produced by ETSI Technical Committee Electromagnetic compatibility and Radio spectrum Matters (ERM).

The present document is part 1 of a multi-part deliverable covering Short Range Devices (SRD) and Ultra Wide Band (UWB), as identified below:

**Part 1: "Measurement techniques for transmitter requirements";**

Part 2: "Measurement techniques for receiver requirements".

National transposition dates	
Date of adoption of this EN:	22 February 2021
Date of latest announcement of this EN (doa):	31 May 2021
Date of latest publication of new National Standard or endorsement of this EN (dop/e):	30 November 2021
Date of withdrawal of any conflicting National Standard (dow):	30 November 2021

---

## Modal verbs terminology

In the present document "**shall**", "**shall not**", "**should**", "**should not**", "**may**", "**need not**", "**will**", "**will not**", "**can**" and "**cannot**" are to be interpreted as described in clause 3.2 of the [ETSI Drafting Rules](#) (Verbal forms for the expression of provisions).

"**must**" and "**must not**" are **NOT** allowed in ETSI deliverables except when used in direct citation.



---

# Introduction

Ultra Wide Band (UWB) radio technology enables a new generation of high-speed data devices for short-range communication purposes as well as location tracking and Sensor devices and opens new markets with a variety of innovative applications.

UWB devices may form an integral part of other portable electronic equipment such as future generation cellular phones or laptops equipped with UWB enabled short-range air interfaces.

In addition, UWB devices with an operating frequency range of several hundreds of MHz up to several GHz allow tens of centimetre-level accuracy real time localization and positioning even in the presence of severe multipath effects caused by walls, furniture or any other harsh radio propagation environments.

Based on the broad variety of different applications and the broad possible frequency range of operation the number of possible deployed physical signal formats can be very large. The existing range of physical signal and modulation formats range from traditional carrier based systems like OFDM over spread spectrum based system to carrier less systems based on base band pulses. The frequency regulation on the other side only defines a single set of transmission limits and values, which have to be fulfilled by all systems under the UWB regulation. Furthermore, the very high channel bandwidth of a UWB signal gives a specific challenge to the needed measurement setup and the procedures. Existing measurement methods need to be extended and new possible techniques should be described in the present document.

The present document is structured as follows:

- Clauses 1 through 3 provide a general description on the types of equipment covered by the present document and the definition of terms, symbols and abbreviations used.
- Clause 4 provides an overview on the technical and technology basics which were considered during the preparation of the present document.
- Clause 5 specifies EUT TX requirements and the related conformance procedure.
- Annex A provides information on test conditions, used test sites and procedures.
- Annex B provides necessary information on radiated test procedures.
- Annex C provides information on TX signal types.
- Annex D provides information on the all emission concept.
- Annex E provides information for a pre-scan radiated power measurement test procedure.
- Annex F provides information on differences between the different emission power measurements.
- Annex G provides a change history table containing the major technical changes.

---

# 1 Scope

The present document summarizes the available information of possible measurement techniques and procedures for the conformance measurement of various signal formats (e.g. Ultra Wide Band) in order to comply with the given transmission limits given in the current regulation.

The present document could be used as a reference for existing and future ETSI standards covering UWB and other technologies.

---

## 2 References

### 2.1 Normative references

References are either specific (identified by date of publication and/or edition number or version number) or non-specific. For specific references, only the cited version applies. For non-specific references, the latest version of the referenced document (including any amendments) applies.

Referenced documents which are not found to be publicly available in the expected location might be found at <https://docbox.etsi.org/Reference/>.

NOTE: While any hyperlinks included in this clause were valid at the time of publication, ETSI cannot guarantee their long term validity.

The following referenced documents are necessary for the application of the present document.

- [1] ETSI TS 102 754: "Electromagnetic compatibility and Radio spectrum Matters (ERM); Short Range Devices (SRD); Technical characteristics of Detect And Avoid (DAA) mitigation techniques for SRD equipment using Ultra Wideband (UWB) technology".
- [2] ETSI TS 102 321: "Electromagnetic compatibility and Radio spectrum Matters (ERM); Normalized Site Attenuation (NSA) and validation of a fully lined anechoic chamber up to 40 GHz".

### 2.2 Informative references

References are either specific (identified by date of publication and/or edition number or version number) or non-specific. For specific references, only the cited version applies. For non-specific references, the latest version of the referenced document (including any amendments) applies.

NOTE: While any hyperlinks included in this clause were valid at the time of publication, ETSI cannot guarantee their long term validity.

The following referenced documents are not necessary for the application of the present document, but they assist the user with regard to a particular subject area.

- [i.1] ETSI TS 103 060: "Electromagnetic compatibility and Radio spectrum Matters (ERM); Short Range Devices (SRD); Method for a harmonized definition of Duty Cycle Template (DCT) transmission as a passive mitigation technique used by short range devices and related conformance test methods".
- [i.2] ITU Radio Regulations.

NOTE: Available at <https://www.itu.int/pub/R-REG-RR/en>.

- [i.3] ECC/DEC/(06)04: "ECC Decision of 24 March 2006 on the harmonised conditions for devices using UWB technology in bands below 10.6 GHz, amended 9 December 2011 and amended 8 March 2019".

- [i.4] ECC/DEC/(07)01: "ECC Decision of 30 March 2007 on the harmonised use, exemption from individual licensing and free circulation of Material Sensing Devices using Ultra-Wideband (UWB) technology, amended on 26 June 2009, corrected on 18 November 2016 and amended on 8 March 2019".
- [i.5] 2019/785/EC: "Commission Implementing Decision (EU) 2019/785 of 14 May 2019 on the harmonisation of radio spectrum for equipment using ultra-wideband technology in the Union and repealing Decision 2007/131/EC (notified under document C(2019) 3461)".
- [i.6] ECC/DEC/(11)02: "ECC Decision of 11 March 2011 on industrial Level Probing Radars (LPR) operating in frequency bands 6-8.5 GHz, 24.05-26.5 GHz, 57-64 GHz and 75-85 GHz", updated on 17 November 2017 and amended on 5 July 2019.
- [i.7] ERC/REC 70-03: "ERC Recommendation of 1997 on relating to the use of Short Range Devices (SRD)".
- NOTE: Available at [https://efis.cept.org/sitecontent.jsp?sitecontent=srd\\_regulations](https://efis.cept.org/sitecontent.jsp?sitecontent=srd_regulations).
- [i.8] 2019/1345/EC: "Commission Implementing Decision (EU) 2019/1345 of 2 August 2019 amending Decision 2006/771/EC updating harmonised technical conditions in the area of radio spectrum use for short-range devices (notified under document C(2019) 5660)".
- [i.9] ERC/REC 74-01: "ERC Recommendation of 1998 on unwanted Emissions in the Spurious Domain, latest amendment on 29 May 2019".
- [i.10] Recommendation ITU-R SM.329-12 (09/2012): "Unwanted emissions in the spurious domain".
- [i.11] ECC/DEC(06)08: "ECC Decision of 1 December 2006 on the conditions for use of the radio spectrum by Ground- and Wall- Probing Radar (GPR/WPR) imaging systems", updated on 26 October 2018.
- [i.12] ETSI EN 302 372: "Short Range Devices (SRD); Tank Level Probing Radar (TLPR) equipment operating in the frequency ranges 4,5 GHz to 7 GHz, 8,5 GHz to 10,6 GHz, 24,05 GHz to 27 GHz, 57 GHz to 64 GHz, 75 GHz to 85 GHz; Harmonised Standard covering the essential requirements of article 3.2 of the Directive 2014/53/EU".
- [i.13] ECC/DEC/(04)03: "ECC Decision of 19 March 2004 on the frequency band 77-81 GHz to be designated for the use of Automotive Short Range Radars".
- [i.14] ETSI TR 103 181-2: "Electromagnetic compatibility and Radio spectrum Matters (ERM); Short Range Devices (SRD) using Ultra Wide Band (UWB);Transmission characteristics Part 2: UWB mitigation techniques".
- [i.15] ETSI TR 103 181-1: "Short Range Devices (SRD) using Ultra Wide Band (UWB); Technical Report Part 1: UWB signal characteristics and overview CEPT/ECC and EC regulation".
- [i.16] ECC Report 120 (07/2008): "Technical requirements for UWB DAA (Detect and Avoid) devices to ensure the protection of radiolocation services in the bands 3.1 - 3.4 GHz and 8.5 - 9 GHz and BWA terminals in the band 3.4 - 4.2 GHz".
- [i.17] ETSI EG 203 367: "Guide to the application of harmonised standards covering articles 3.1b and 3.2 of the Directive 2014/53/EU (RED) to multi-radio and combined radio and non-radio equipment".
- [i.18] ETSI TR 100 028 (all parts) (V1.4.1) (12-2001): "Electromagnetic compatibility and Radio spectrum Matters (ERM); Uncertainties in the measurement of mobile radio equipment characteristics".
- [i.19] Recommendation ITU-R SM.1754-0 (05/2006): "Measurement techniques of ultra-wideband transmissions".
- [i.20] ANSI C63.5-2017/Cor 1-2019: "American National Standard for Electromagnetic Compatibility- Radiated Emission Measurements in Electromagnetic Interference (EMI) Control - Calibration and Qualification of Antennas (9 kHz to 40 GHz) - Corrigendum 1".

- [i.21] ETSI TR 102 273 (all parts) (V1.2.1) (12-2001): "Electromagnetic compatibility and Radio spectrum Matters (ERM); Improvement on Radiated Methods of Measurement (using test site) and evaluation of the corresponding measurement uncertainties".
- [i.22] ETSI TR 102 215: "Electromagnetic compatibility and Radio spectrum Matters (ERM); Recommended approach, and possible limits for measurement uncertainty for the measurement of radiated electromagnetic fields above 1 GHz".
- [i.23] ECC Report 064: "The protection requirements of radiocommunications systems below 10.6 GHz from generic UWB applications".
- [i.24] Recommendation ITU-R SM.1755-0 (05/2006): "Characteristics of ultra-wideband technology".
- [i.25] ETSI TR 102 347: "Electromagnetic compatibility and Radio spectrum Matters (ERM); Short Range Devices (SRD); Equipment for Detecting Movement; Radio equipment operating around e.g. 5,8 GHz, 10 GHz, 25 GHz, 61 GHz, 77 GHz; System Reference Document for Tank Level Probing Radar (TLPR)".
- [i.26] ECC Report 139: "Impact of Level Probing Radars (LPR), using Ultra-Wideband Technology on Radiocommunications Services".
- [i.27] Recommendation ITU-R SM.1541-6 (08/2015): "Unwanted emissions in the out-of-band domain; SM Series".
- [i.28] ETSI EN 303 446-1: "ElectroMagnetic Compatibility (EMC) standard for combined and/or integrated radio and non-radio equipment; Part 1: Requirements for equipment intended to be used in residential, commercial and light industry locations".
- [i.29] ETSI EN 303 446-2: "ElectroMagnetic Compatibility (EMC) standard for combined and/or integrated radio and non-radio equipment; Part 2: Requirements for equipment intended to be used in industrial locations".
- [i.30] RBW influence on peak or mean power measurement of pulsed signals, Application Note 6.2019-1EF106-1E, 06.06.2019.

NOTE: Available at [https://www.rohde-schwarz.com/pk/applications/rbw-influence-on-peak-or-mean-power-measurement-of-pulsed-signals-application-note\\_56280-648522.html](https://www.rohde-schwarz.com/pk/applications/rbw-influence-on-peak-or-mean-power-measurement-of-pulsed-signals-application-note_56280-648522.html).

- [i.31] ETSI EN 302 729-1: "Electromagnetic compatibility and Radio spectrum Matters (ERM); Short Range Devices (SRD); Level Probing Radar (LPR) equipment operating in the frequency ranges 6 GHz to 8,5 GHz, 24,05 GHz to 26,5 GHz, 57 GHz to 64 GHz, 75 GHz to 85 GHz; Part 1: Technical characteristics and test methods".
- [i.32] Directive 2014/53/EU of the European Parliament and of the Council of 16 April 2014 on the harmonisation of the laws of the Member States relating to the making available on the market of radio equipment and repealing Directive 1999/5/EC (RED).
- [i.33] CISPR 16-1-6:2014: "Specification for radio disturbance and immunity measuring apparatus and methods - Part 1-6: Radio disturbance and immunity measuring apparatus - EMC antenna calibration".

---

## 3 Definition of terms, symbols and abbreviations

### 3.1 Terms

For the purposes of the present document, the following terms apply:

**All Emissions (AE):** related UWB Emission of the transmitter (RP), Transmitter Unwanted Emissions (TXUE) and Other Emissions (OE) of the EUT

NOTE: See emission concept in clause 5.1.2.1.

**antenna cycle:** one complete sweep of a mechanically or electronically scanned antenna beam along a predefined spatial path

**antenna scan duty factor:** ratio of the solid angle of the antenna beam (measured at its 3 dB point) to the total solid angle scanned by the antenna

**associated antenna:** antenna and all its associated components which are designed as an indispensable part of the equipment

**avoidance level:** maximum amplitude to which the UWB transmit power is set for the relevant protection zone

**burst:** emitted signal whose time duration ( $T_{on}$ ) is not related to its bandwidth

**co-located receiver:** receiver is located in the same device housing as the transmitter

**combined equipment:** any combination of non-radio equipment and a plug-in radio device that would not offer full functionality without the radio device

**dedicated antenna:** removable antenna supplied and tested with the radio equipment, designed as an indispensable part of the equipment

**default avoidance bandwidth:** portion of the victim service bandwidth to be protected if no enhanced service bandwidth identification mechanisms are implemented in the DAA enabled devices

**detect and avoid time:** time duration between a change of the external RF environmental conditions and adaptation of the corresponding UWB operational parameters

**Duty Cycle:** the ratio, expressed as a percentage, of  $\Sigma(T_{on})/(T_{obs})$  where  $T_{on}$  is the "on" time of a single transmitter device and  $T_{obs}$  is the observation period, see ETSI TS 103 060 [i.1]

**Effective Radiated Power (E.R.P.):** product of the power supplied to the antenna and its gain relative to a half-wave dipole in a given direction (RR 1.162)

**equivalent isotopically radiated power (e.i.r.p.):** product of the power supplied to the antenna and the antenna gain in a given direction relative to an isotropic antenna (absolute or isotropic gain)

NOTE: See ITU Radio Regulations [i.2], RR 1.161.

**far field measurement:** measurement at a distance from an antenna sufficient to ensure that the electro-magnetic field approximates a plane wave (see clause B.2.1)

**frequency span:** frequency range between the start and stop frequency of the RP measurement set-up

**gating:** transmission that is intermittent or of a low duty cycle referring to the use of burst transmissions where a transmitter is switched on and off for selected time intervals

**hopping:** spread spectrum technique whereby individual radio links are continually switched from one subchannel to another

**hopping cycle:** number of hopping positions for a full frequency hopping sequence

**host equipment:** any equipment which has complete user functionality when not connected to the radio equipment part and to which the radio equipment part provides additional functionality and to which connection is necessary for the radio equipment part to offer functionality

**impulse:** pulse whose width is determined by its dc step risetime and whose maximum amplitude is determined by its dc step value

**indirect emissions:** emissions radiated in all directions in a specified scenario (see clause 5.7, including direct emissions from the housing/structure of the equipment and emissions reflected or passing through a media under inspection or through a scenario)

NOTE: These emissions are sometimes also named an exterior limit or unwanted emissions.

**integral antenna:** permanent fixed antenna, which may be built-in, designed as an indispensable part of the equipment

**main beam direction:** direction of maximum gain of a directional antenna

NOTE: EUT may have different main beam direction for TX and RX antennas.

**mean power:** power during an interval of time sufficiently long compared with the lowest frequency encountered in the modulation envelope

**minimum avoidance bandwidth:** portion of the victim service bandwidth requiring protection

**minimum initial channel availability check time:** minimum time the UWB radio device spends searching for victim signals after power on, Parameter:  $T_{avail, Time}$

**Non-Interference Mode operation (NIM):** operational mode that allows the use of the radio spectrum on a non-interference basis without active mitigation techniques

**operating frequency range:** frequency range over which the EUT is intentionally transmitting

NOTE 1: The operating frequency range of the EUT is determined by the lowest ( $f_L$ ) and highest frequency ( $f_H$ ).

NOTE 2: For analogue or discrete frequency modulated systems (FSK, FMCW) the operating frequency range covers the difference between minimum and maximum of all carrier frequencies on which the equipment can be adjusted.

**peak power:** power measured with the peak detector using a filter the width and shape of which is sufficient to accept the signal bandwidth (see Recommendation ITU-R SM.1541-6 [i.27])

**permitted frequency range(s):** frequency range(s) within which the device is authorized to operate

**plug-in radio device:** radio equipment module intended to be used with or within host, combined or multi-radio equipment, using their control functions and power supply

**Power Spectral Density (PSD):** ratio of the amount of power within a specified bandwidth

**pulse:** short transient signal whose time duration is nominally the reciprocal of its -10 dB bandwidth

**(mean) Pulse Repetition Frequency (PRF):** inverse of the Pulse Repetition Interval, averaged over a time sufficiently long as to cover all PRI variations

**Pulse Repetition Interval (PRI):** time between the rising edges of the transmitted (pulsed) output power

**Radar Cross Section (RCS):** cross-sectional area of a perfectly reflecting sphere that would produce the same strength reflection as would the object in question

**rf carrier:** fixed radio frequency prior to modulation

**scanning (steerable) antenna:** directional antenna which can move its beam along a predefined spatial path

NOTE: Scanning can be realized by mechanical, electronic or combined means. The antenna beamwidth may stay constant or change with the steering angle, dependent on the steering method.

**second (2<sup>nd</sup>) harmonic:** twice the frequency of the fundamental (e.g. 48 GHz for a 24 GHz device)

**signal detection threshold set:** set of amplitudes of the victim signal which defines the transition between adjacent protection zones

**signal off time ( $T_{off}$ ):** one or more time periods within the signal repetition time, where no transmission occurs

**signal repetition time:** length of the time between subsequent transmission patterns of the system

NOTE: Also known as cycle time, frame repetition time or frame duration.

**stand-alone radio equipment:** equipment intended primarily as communications equipment and that is normally used on a stand-alone basis

**transmission:** sequence of emissions separated by intervals shorter than  $T_{dis}$ , ETSI TS 103 060 [i.1]

**transmitter timeout functionality:** internal functionality that switches off the system in order to reduce power consumption or for regulatory reasons

**victim signal:** signal(s) of the service to be detected and protected by the DAA mitigation technique

**wideband:** emission whose occupied bandwidth is greater than the test equipment measurement bandwidth

## 3.2 Symbols

For the purposes of the present document, the following symbols apply:

$\Omega$	ohm
$\lambda$	wavelength
$\sigma$	standard deviation
$\Theta$	elevation angle
$\Phi$	azimuth angle
$B_{wrel}$	relation of the bandwidth
$C_{ATT\ total}$	attenuation from the EUT reference plane to the spectrum analyser
$D$	detection threshold
dB	decibel
dBc	decibel below the maximum
dB <sub>i</sub>	gain in decibels relative to an isotropic antenna
dB <sub>m</sub>	gain in decibels relative to one milliwatt
$f$	frequency
$f_c$	centre frequency for the filter
$f_L$	lowest frequency of the operating frequency range
$f_H$	highest frequency of the operating frequency range
$f_C$	centre frequency of the operating frequency range
$f_M$	frequency for peak power measurement
$f[t]$	filter coefficients at time $t$ , centred on $f_M$
$G$	gain
$G_{ATT}$	attenuator loss
$G_{LNA}$	gain low noise amplifier
$I$	isolation in dB
$P$	power in dBm
$P_{av}$	mean e.i.r.p. power spectral density
$P_{peak,filtered}$	peak power in filter bandwidth
$P_{peak,max}$	maximum peak power in filter bandwidth
$P_{pk}$	peak e.i.r.p. spectral density power
$R$	distance
$T_{avail\_time\_min}$	minimum initial channel availability check time
$T_{avoid}$	detect and avoid time

NOTE: Actual Detect and Avoid time of a EUT, can be negative.

$T_{avoid\_max}$	maximum allowed Detect and avoid time
$T$	time
$t$	discrete time variable
$T_{dis}$	time interval below which interruptions within a transmission are considered part of $T_{on}$ (disregard time), ETSI TS 103 060 [i.1]
$T_{obs}$	reference interval of time (observation period, ETSI TS 103 060) [i.1]
$T_{off}$	time interval between two consecutive bursts when the UWB emission is kept idle

NOTE:  $T_{off}$  is defined as "the time duration between two consecutive transmissions", ETSI TS 103 060 [i.1].

$T_{on}$  duration of a burst irrespective of the number of pulses contained

NOTE:  $T_{on}$  is defined as "the duration of a transmission".

$T_{rep}$  repetition time  
 $V_{peak,filtered}$  peak voltage in filter bandwidth  
 $Z_0$  characteristic impedance

### 3.3 Abbreviations

For the purposes of the present document, the following abbreviations apply:

AC Alternating Current  
 AE All Emissions

NOTE: AE used to be referred to as "Total Emission" (TE) in previous versions of the present document.

APC Adaptive Power Control  
 BWA Broadband Wireless Access  
 CON Connector  
 DAA Detect And Avoid  
 dc direct current  
 DC Duty Cycle  
 DEC DECision  
 EC European Commission  
 ECC European Communication Committee  
 e.i.r.p. equivalent isotropically radiated power  
 EMC Electromagnetic Compatibility  
 EN European Norm  
 ERC European Radiocommunications Committee  
 ERM Electromagnetic compatibility and Radio spectrum Matters  
 ETSI European Telecommunications Standards Institute  
 EU European Union  
 EUT Equipment Under Test  
 FH Frequency Hopping  
 FMCW Frequency Modulated Continuous Wave  
 FSL Free Space Loss  
 GPR Ground Probing Radar  
 HS Harmonised Standard  
 IF Intermediate Frequency  
 ITU International Telecommunications Union  
 LBT Listen Before Talk  
 LDC Low Duty Cycle  
 LNA Low Noise Amplifier  
 LPR Level Probing Radar  
 MSS Mobile Satellite Service  
 NIM Non-Interference Mode operation  
 OATS Open Area Test Site  
 OE Other Emissions of the radiated emissions  
 OFDM Orthogonal Frequency Division Multiple  
 OFR Operating Frequency Range  
 OOB Out-Of-Band  
 PPM Part Per Million  
 PRF Pulse Repetition Frequency  
 PRI Pulse Repetition Interval  
 PSD Power Spectral Density  
 RBW Resolution BandWidth  
 REC RECommendation  
 RF Radio Frequency  
 RMS Root Mean of Squares



RP Radiated Power

NOTE: RP refers to the wanted signal emission. Previous versions of the present document used to refer to this as UWB Emissions (UE).

RX	Receiver
SNR	Signal to Noise Ratio
SRD	Short Range Device
SWT	Sweep Time
TLPR	Tank Level Probing Radar
TPC	Transmit Power Control
TRP	Total Radiated Power
TX	Transmitter
TXUE	Transmitter Unwanted Emissions
UUT	Unit Under Test
UWB	Ultra Wide Band
VBW	Video BandWidth
VSWR	Voltage Standing Wave Ratio
WPR	Wall Probing Radar
UE	UWB Emissions

## 4 Overview

### 4.1 Information

The present document provides practical information and guidance for the compliance tests of UWB and Short Range technology and devices. The applicability of the procedures described in the present document is not limited to EUT covered for example by following regulations:

- ECC/DEC/(06)04 [i.3].
- ECC/DEC/(07)01 [i.4].
- 2019/785/EC [i.5].
- ECC/DEC/(11)02 [i.6].
- 2019/1345/EC [i.8].
- ECC/DEC/(04)03 [i.13].

Or radio determination applications realized based on:

- ERC/REC 70-03 [i.7].

### 4.2 Basic information about UWB

More information on UWB technology is available in ETSI TR 103 181-1 [i.15] (UWB signals) and ETSI TR 103 181-2 [i.14] (UWB mitigation techniques). The basic regulatory studies for UWB < 10 GHz are available in ECC Report 064 [i.23] and ITU Recommendation ITU-R SM.1755-0 [i.24].

---

## 5 TX requirements

### 5.1 General

#### 5.1.1 General Guidance on TX measurements

The test procedures in the clauses 5.2 to 5.11 can directly be used for EUT with a permanent or temporary antenna connector without additional requirements on test antennas, test sites etc., clause B.3 provides relevant information for conducted measurements.

More information on how to perform radiated tests, including on EUT without a permanent or temporary antenna connector, is provided in clause B.2.

Further important information for TX measurements is provided in annex A, for example:

- Test modulation (see clause A.3)
- Test conditions, power supply and ambient temperatures (see clause A.5)
- Measurement uncertainty and the interpretation of the measurement results (see clause A.8)

#### 5.1.2 Emission Concept

##### 5.1.2.1 General

The measured emissions in transmit mode of the EUT are the combination of:

- 1) Radiated Power from the transmitter (see clause 5.3).
- 2) Other Emissions (OE) from the transmitter, receiver and other analogue or digital circuitry (see clause 5.4).
- 3) TX Unwanted Emissions (TXUE) from the transmitter (out-of-band and spurious domain, see clause 5.5).
- 4) Total radiated power (see clause 5.6).
- 5) Indirect emissions (see clause 5.7).

The UWB Radiated Power (RP) are the emissions related to the signal radiated into free space (see clause 5.3) during the transmit mode(s) of operation or radiated indirectly into the air (see clause 5.7).

For some EUT the UWB Radiated Power (RP) and TX Unwanted Emissions (TXUE) cannot be measured independently of the Other Emissions (OE) (e.g. narrow-band spurious emissions and the analogue or digital control circuitry emissions). That is because in some frequency ranges the regulated UWB RP emissions are very low power radio signals, comparable to the power limits of emissions from digital and analogue circuitry. If based on a measurement as described in annex D it can be assessed that an emission from the EUT is not the UWB RP emission limited in the relevant harmonised standards or it can clearly be assessed that it is impossible to differentiate between other emissions OE and the UWB RP emissions, the emission shall be considered as other emissions OE.

For such cases the RP, TXUE and OE from the EUT together are specified for such purpose of the test: as All Emissions (AE) see annex D.

##### 5.1.2.2 UWB - EUT

The test concept is based on operating frequency range including the relevant UWB TX requirements. Figure 1 shows an overview of the TX emissions and mitigations.

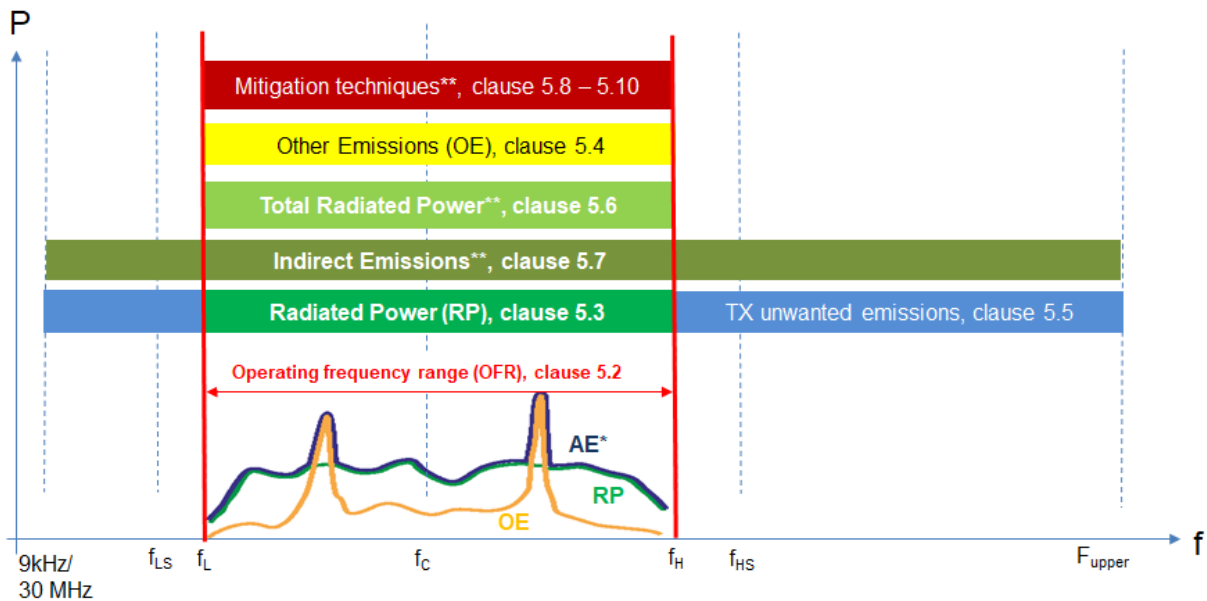

\*: AE; All Emissions, requirement is not mandatory for all EUT, details see annex D or related standard.  
 \*\*: Not mandatory for all EUT, see related standard.

Figure 1: TX emission concept

## 5.2 Operating Frequency Range (OFR)

### 5.2.1 Definition

The operating frequency range is the frequency range over which the EUT is intentionally transmitting (see clause 5.3, radiated power). The operating frequency range of the EUT is determined by the lowest ( $f_L$ ) and highest frequency ( $f_H$ ), see figure 2.

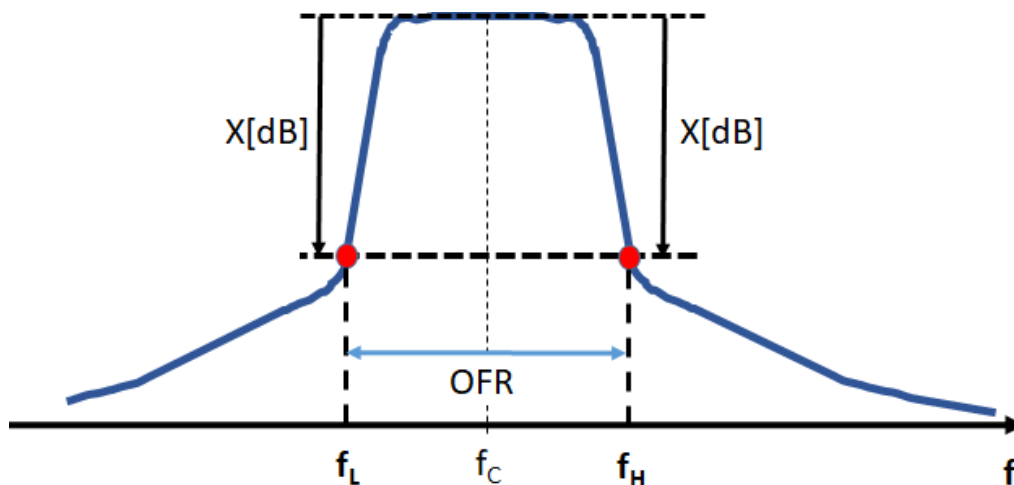

Figure 2: Operating Frequency Range (OFR)

The lowest ( $f_L$ ) and highest frequency ( $f_H$ ) shall be measured  $X$  dB below the max emission (see figure 2). The value for  $X$  is given in the related standard. If no value for  $X$  is provided in the related standard, then the value of 23 dB shall be used.

An EUT can have more than one operating frequency range. In that case each operating frequency range shall be tested separately.

## 5.2.2 Conformance Test

The operating frequency range assessment procedure shall be as follows:

- use if available the recorded results of the radiated power spectral density measurements to specify the emissions over the complete frequency range given in the relevant harmonised standard;
- if no method for power spectral density measurement is required in the related standard, the related standard should specify the method for the measurement of the OFR;
- find the frequency ( $f_M$ ) at which the highest emission level occurs, this frequency shall be recorded;
- find the lowest frequency ( $f_L$ ) below  $f_M$  at which emission decrease to the level defined in clause 5.2.1. This frequency shall be recorded;
- find the highest frequency ( $f_H$ ) above  $f_M$  at which the emission level decreases to the level defined in clause 5.2.1. This frequency shall be recorded;
- the difference between the lowest frequency ( $f_L$ ) and highest frequency ( $f_H$ ) is the operating frequency range (OFR) which shall be calculated (see (1)) and recorded:

$$\text{OFR} = f_H - f_L \quad (1)$$

- the addition of the lowest frequency and highest frequency divided by two is the centre frequency ( $f_C$ ) which shall be calculated (see (2)) and recorded:

$$f_C = \left( \frac{f_L + f_H}{2} \right) \quad (2)$$

- the values for  $f_H$ ,  $f_L$  and OFR shall be assessed with the OFR requirements specified in the related standard.

## 5.3 Radiated Power (RP)

### 5.3.1 Mean e.i.r.p.

#### 5.3.1.1 Description

The radiated mean e.i.r.p. of the EUT, at a particular frequency is the product of the mean power supplied to the antenna and the antenna gain in a given direction relative to an isotropic antenna.

The maximum mean e.i.r.p. is the mean power radiated in the direction of the maximum level (usually the boresight of the antenna).

This radiated power shall be measured in the operating frequency range (see clause 5.2).

#### 5.3.1.2 Conformance

Measurement procedures for mean e.i.r.p. are described in clauses 5.3.1.3, 5.3.1.4 and 5.3.1.5.

#### 5.3.1.3 Method with a Spectrum Analyser

The spectrum analyser shall be connected to the test antenna (see clause B.2.2.5).

When measuring mean power from the EUT, the spectrum analyser (or equivalent) shall be configured as follows (an overview of this procedure is provided in the flowchart in figure 3), unless otherwise stated in the related standard:

- |                  |   |
|------------------|---|
| Start frequency: | Lower edge of the permitted range of operation (see related standard). If nothing is specified in the related standard the pre-scan method (annex E) should be used |
|------------------|---|

Stop frequency: Upper edge of the permitted range of operation (see related standard). If nothing is specified in the related standard the pre-scan method (annex E) should be used

Resolution bandwidth: 1 MHz

NOTE 1: The settling time of the filter should be respected; for an RBW of 1 MHz, the maximum time resolution is 1 MHz/ $\mu$ s. For example, a generally accepted criterion for a pulsed transmitter is  $RBW \geq 2/T_{on}$ . For an FMCW system a maximum frequency ramp of 1 MHz/ $\mu$ s can be measured with an RBW of 1 MHz with corresponding increases in the RBW for faster frequency ramp rates. For more information see "RBW influence on peak or mean power measurement of pulsed signals" [i.30].

Video bandwidth:  $VBW \geq RBW$

Detector mode: RMS

Display mode: CLEAR WRITE

Average Time:  $\geq$  than one EUT signal repetition time (see annex C)

NOTE 2: An integer number of signal repetitions, (e.g. 1 or 2) is recommended to provide consistent results in the shortest possible time.

Sweep time: Average Time  $\times$  number of measurement points

The Channel Power function of a spectrum analyser needs to be used to calculate the mean power from  $f_L$  to  $f_H$ . Boundaries for the calculation needs to be defined in the related standard. This is typically the operating frequency range.

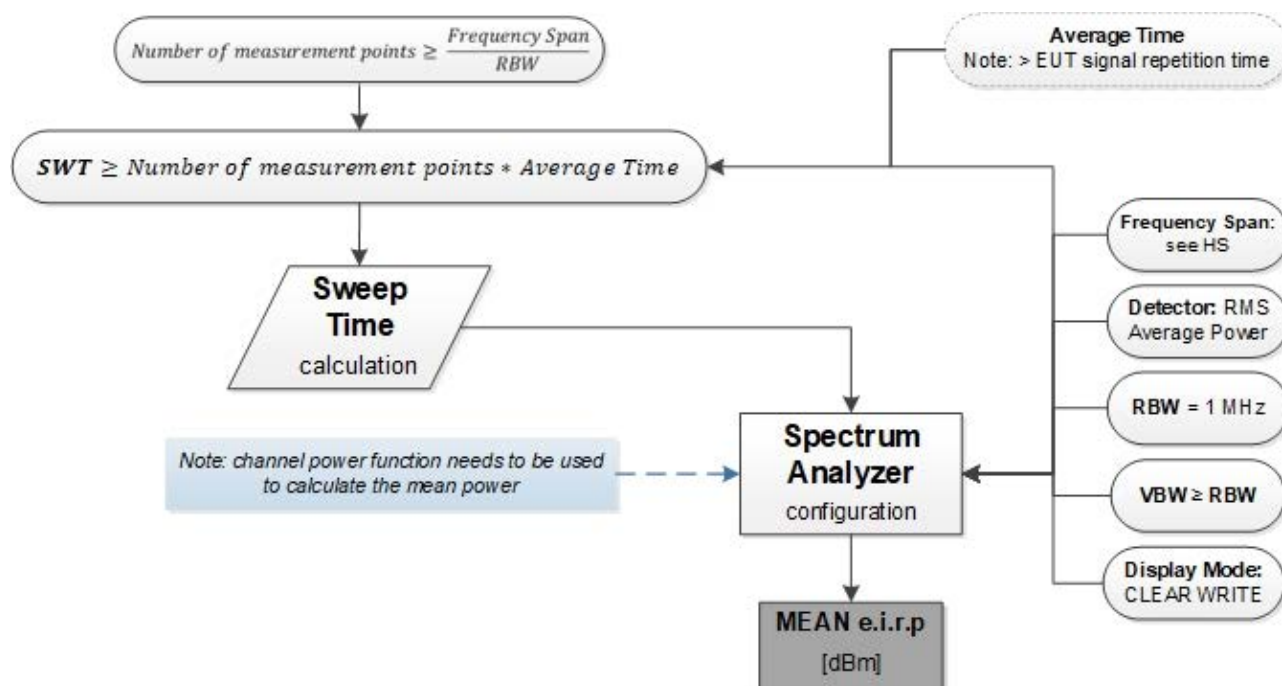

Figure 3: Test Procedure for Mean Power

#### 5.3.1.4 Method with an RMS Power Meter

The RMS power meter shall be connected to the test antenna (see clause B.2.2.5).

The measurement time shall be equal or longer than the EUT signal repetition time (see annex C).

### 5.3.1.5 Method with a Peak Power Meter

The peak power meter shall be connected to the test antenna (see clause B.2.2.5).

The measurement time shall be sufficiently long to cover at least the EUT signal repetition time (see annex C).

The mean power is obtained by multiplying the peak power measured by the peak power meter with the duty cycle measured according to clause 5.11 (see also formula (3)).

$$\text{Mean Power[W]} = \text{Measured Peak Power[W]} \times \text{Duty Cycle} \quad (3)$$

## 5.3.2 Mean e.i.r.p. Spectral Density

### 5.3.2.1 Description

The mean e.i.r.p. spectral density is defined as the emitted power spectral density over a defined bandwidth of the transmitter including antenna gain radiated in the direction of the maximum level under the specified conditions of measurement.

### 5.3.2.2 Guidance for Mean e.i.r.p. Spectral Density Conformance Tests

Guidance to choose the right measurement method.

**Table 1: Guidance to choose right mean e.i.r.p. spectral density measurement procedure**

Kind of signal characteristic	Related regulation (examples, but not limited to)	Clause 5.3.2.3	Clause 5.3.2.4	Clause 5.3.2.5
Case 1: Any signal which has to be averaged over 1 ms per measurement point	EUT based on the ECC and EC UWB regulatory framework below 10 GHz ECC/DEC/(06)04 [i.3] ECC/DEC/(07)01 [i.4] 2019/785/EC [i.5]	X		
Case 2: Alternative for type 1 (1 ms averaging time) for signals with signal repetition time (> 1 ms) and constant in time	EUT based on the ECC and EC UWB regulatory framework below 10 GHz ECC/DEC/(06)04 [i.3] ECC/DEC/(07)01 [i.4] 2019/785/EC [i.5]	(X)	X	
Case 3: Without requirement on measurement time in regulation; averaged over one or more integer multiple of the signal repetition time per measurement point	For all other EUT e.g.: ECC/DEC/(11)02 [i.6] Generic SRDs based on ERC REC 70-03 [i.7] and 2019/1345/EC decision for SRDs [i.8]			X

### 5.3.2.3 Mean e.i.r.p. Spectral Density, averaged over 1 ms

The following measurements shall be applied to the combination(s) of the radio device and its intended antenna(s). In the case that the RF power level is user adjustable, all measurements shall be made with the highest power level available to the user for that combination.

When measuring maximum mean power spectral density from the EUT, the spectrum analyser (or equivalent) shall be configured as follows (an overview of this procedure is provided in the flowchart in figure 4), unless otherwise stated in the related standard:

Start frequency:	Lower edge of the permitted range of operation (see related standard). If nothing is specified in the related standard the pre-scan method (annex E) should be used
Stop frequency:	Upper edge of the permitted range of operation (see related standard). If nothing is specified in the related standard the pre-scan method (annex E) should be used
Resolution Bandwidth:	1 MHz

Video Bandwidth: Not less than the resolution bandwidth

Detector Mode: RMS

Display Mode: Max. Hold

Average Time: 1 ms (sweep time per measurement point)

NOTE: "Average Time" may not be an explicit setting. In some cases, it may be determined by setting the number of measurement points and the time taken for a sweep (see formula (5) below).

Number of measurement points: At least equal to frequency span divided by RBW

Sweep Time: Time for spectrum analyser sweep (over one span). Appropriate settings shall be calculated with the following formulas (4) and (5):

$$\text{Number of measurement points} \geq \frac{\text{Frequency Span}}{\text{RBW}} \quad (4)$$

$$\text{Sweep Time (SWT)} \leq \text{Number of measurement points} \times 1 \text{ ms} \quad (5)$$

Wait for each measurement until the reading in the display is stable.

In case of signals with a repetition time (see annex C) greater than 1 ms the initial measurement sweep will not give the final result. Therefore, several sweeps with display mode "max hold" are necessary to get the final, stable result. This can be assumed to be achieved if a further increase of time for the max hold measurement will not further change the result anymore. The number of sweeps necessary may be predicted with the knowledge of the signal repetition time by the following formula (6):

$$\text{Number of sweeps} \geq \frac{\text{maximum signal repetition time}}{1 \text{ ms}} \quad (6)$$

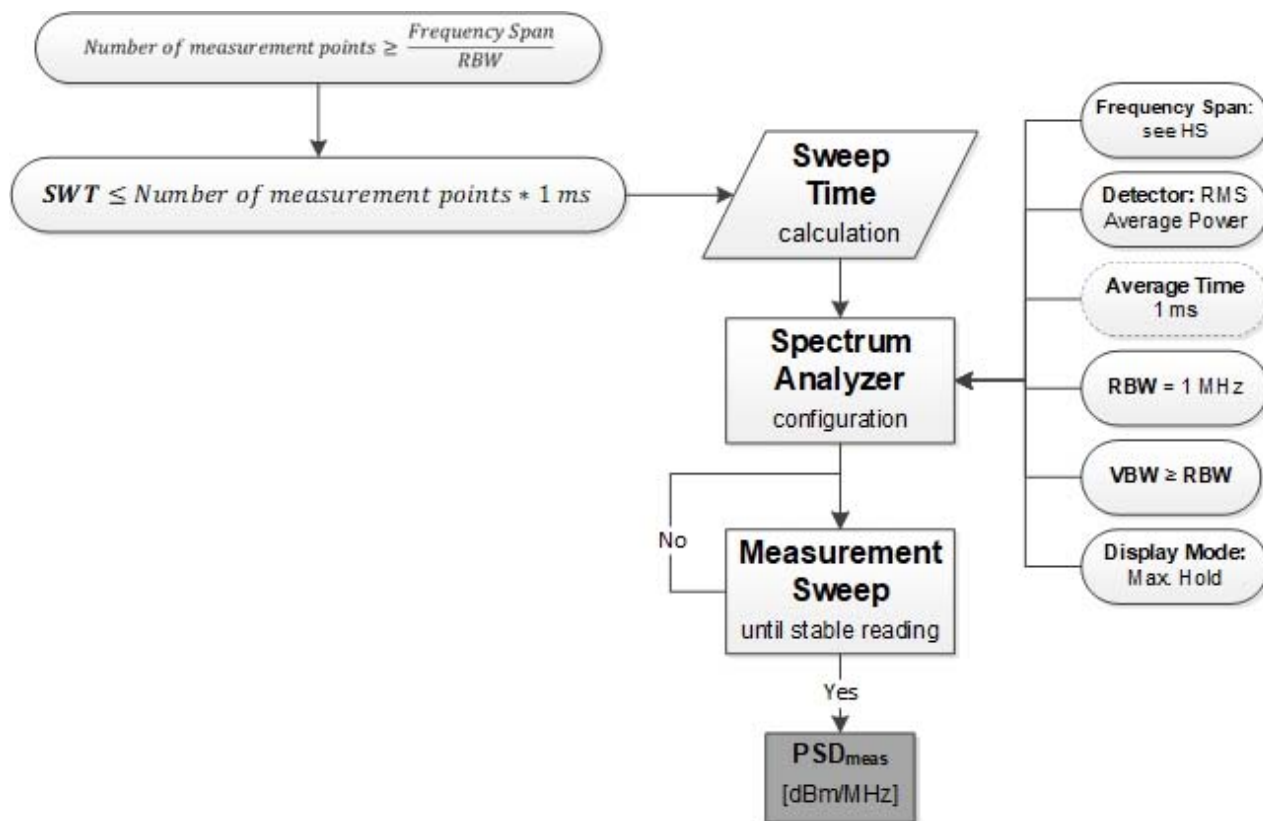

**Figure 4: Test Procedure for Mean e.i.r.p. spectral density, Method 1**

The measurement results shall be recorded and used to determine the OFR and to assess the Mean e.i.r.p. spectral density limits within the OFR.

### 5.3.2.4 Mean e.i.r.p. Spectral Density, known signal repetition time, averaged over 1 ms

The following measurements shall be applied to the combination(s) of the radio device and its intended antenna(s). In the case that the RF power level is user adjustable, all measurements shall be made with the highest power level available to the user for that combination.

When measuring maximum mean power spectral density from the EUT, the spectrum analyser (or equivalent) shall be configured as follows (an overview of this procedure is provided in the flowchart in figure 5), unless otherwise stated in the related standard:

Start frequency:	Lower edge of the permitted range of operation (see related standard). If nothing is specified in the related standard the pre-scan method (annex E) should be used
Stop frequency:	Upper edge of the permitted range of operation (see related standard). If nothing is specified in the related standard the pre-scan method (annex E) should be used
Resolution Bandwidth:	1 MHz
Video Bandwidth:	Not less than the resolution bandwidth
Detector Mode:	RMS
Display Mode:	Max. Hold
Average Time:	Equal or larger than signal repetition time (see annex C)

NOTE: "Average Time" may not be an explicit setting. In some cases, it may be determined by setting the number of measurement points and the time taken for a sweep.

Number of measurement points:	at least equal to frequency span divided by RBW
Sweep Time:	Time for spectrum analyser sweep (over one span). Appropriate settings shall be calculated with the following formula (7):

$$\text{Sweep Time (SWT)} \geq \text{EUT signal repetition time} \times \text{Number of measurement points} \quad (7)$$

Signal repetition time:	See annex C
-------------------------	-------------

Based on the longer averaging time than 1 ms, there is a need to correct the measured and recorded values with the following formulas (8) to (9):

$$\text{Correction [dB]} = 10 \log \left( \frac{\text{Averaging time [ms]}}{1 \text{ [ms]}} \right) \quad (8)$$

$$\text{PSD}_{\text{real}} \left[ \frac{\text{dBm}}{\text{MHz}} \right] = \text{PSD}_{\text{meas}} \left[ \frac{\text{dBm}}{\text{MHz}} \right] + \text{Correction [dB]} \quad (9)$$

The radiation measured values (PSD<sub>meas</sub>) shall be corrected with the calculated correction factor (Correction[dB]). The resulting PSD<sub>real</sub> has to comply with the related limits in the relevant harmonised standard.



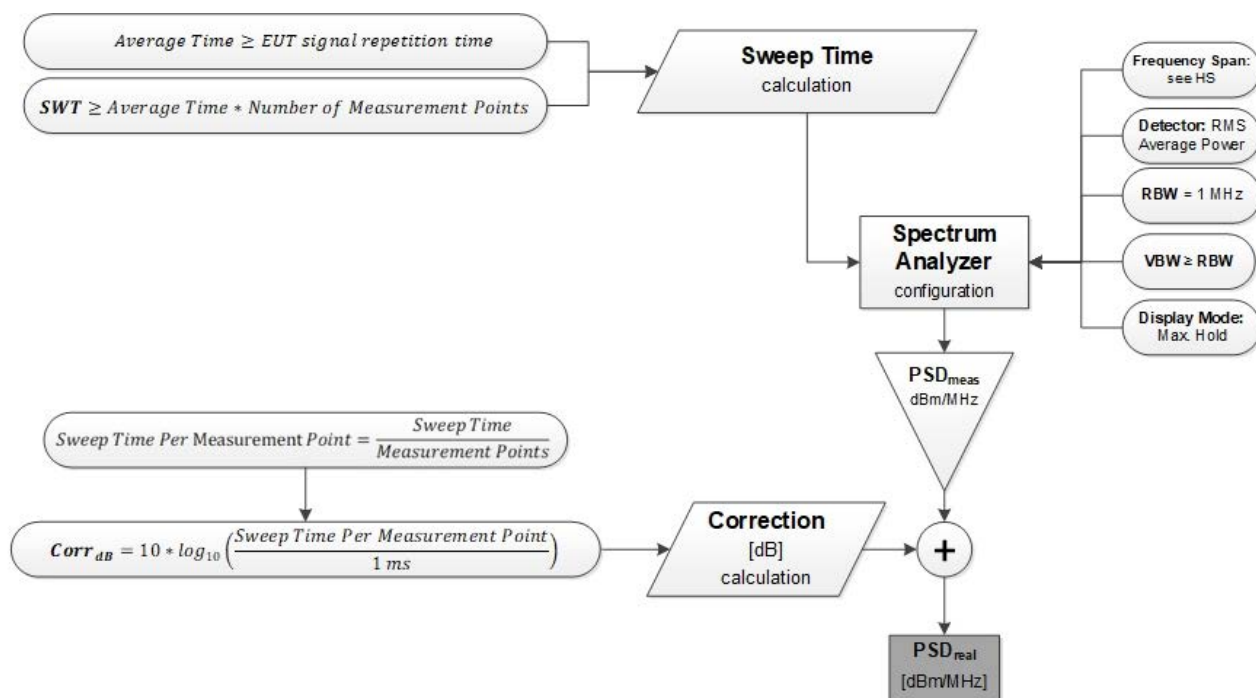

**Figure 5: Test Procedure Mean e.i.r.p. spectral density, Method 2**

The measurement results shall be recorded and used to determine the OFR and to assess the mean power spectral density limits within the OFR.

### 5.3.2.5 Mean e.i.r.p. Spectral Density, known signal repetition time, averaged over signal repetition time

The following measurements shall be applied to the combination(s) of the radio device and its intended antenna(s). In the case that the RF power level is user adjustable, all measurements shall be made with the highest power level available to the user for that combination.

When measuring maximum mean power spectral density from the EUT, the spectrum analyser (or equivalent) shall be configured as follows (an overview of this procedure is provided in the flowchart in figure 6), unless otherwise stated in the related standard:

Start frequency:	Lower edge of the permitted range of operation (see related standard). If nothing is specified in the related standard the pre-scan method (annex E) should be used
Stop frequency:	Upper edge of the permitted range of operation (see related standard). If nothing is specified in the related standard the pre-scan method (annex E) should be used
Resolution Bandwidth:	1 MHz
Video Bandwidth:	Not less than the resolution bandwidth
Detector Mode:	RMS
Display Mode:	Max. Hold
Average Time:	Equal or larger than signal repetition time

NOTE: "Average Time" may not be an explicit setting. In some cases, it may be determined by setting the number of measurement points and the time taken for a sweep.

Number of measurement points: At least equal to frequency span divided by RBW

Sweep Time: Time for spectrum analyser sweep (over one Frequency Span). Appropriate settings shall be calculated with the following formula (10):

$$\text{Sweep Time (SWT)} \geq \text{signal repetition time} \times \text{Number of measurement points} \quad (10)$$

Signal repetition time: See annex C

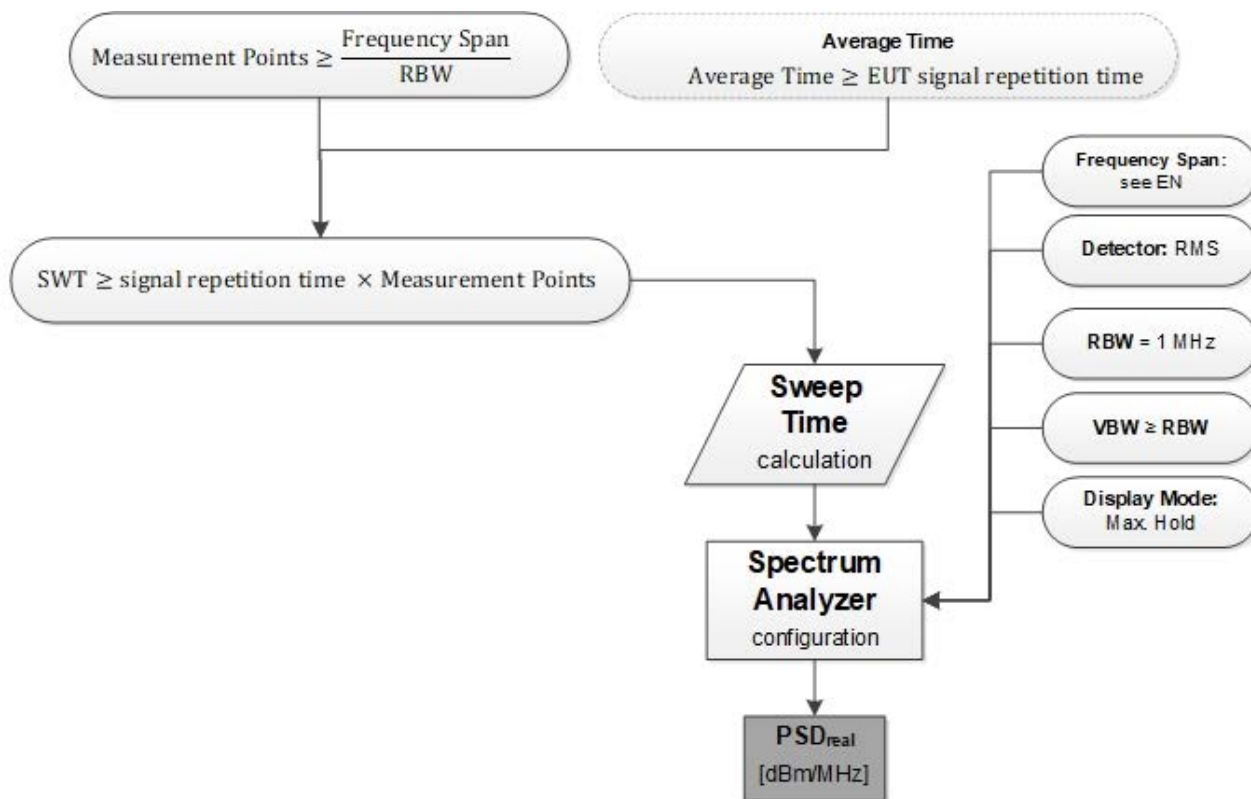

**Figure 6: Test Procedure Mean e.i.r.p. spectral density, Method 3**

The measurement results shall be recorded and used to determine the OFR and to assess the mean power spectral density limits within the OFR.

### 5.3.3 Peak e.i.r.p.

#### 5.3.3.1 Description

The radiated peak power (e.i.r.p.) is the highest instantaneous power radiated by the equipment. It is measured in the permitted range of operating frequency range.

#### 5.3.3.2 Conformance

Three methods are described for measuring the peak e.i.r.p.:

- In clause 5.3.3.3 with a spectrum analyser
- In clauses 5.3.3.4 with average power meter
- In clause 5.3.3.5 with peak power meter

### 5.3.3.3 Peak e.i.r.p.; Method with a Spectrum Analyser

The spectrum analyser shall be connected to the test antenna (see clause B.2.2.5).

A spectrum analyser with the following settings is used as measuring receiver:

Start frequency:	Lower edge of the permitted range of operation (see related standard). If nothing is specified in the related standard the pre-scan method (annex E) should be used
Stop frequency:	Upper edge of the permitted range of operation (see related standard). If nothing is specified in the related standard the pre-scan method (annex E) should be used
Resolution bandwidth:	1 MHz

NOTE 1: The settling time of the filter should be respected; for an RBW of 1 MHz, the maximum time resolution is 1 MHz/ $\mu$ s. For example, a generally accepted criterion for a pulsed transmitter is  $RBW \geq 2/T_{on}$ . For an FMCW system a maximum frequency ramp of 1 MHz/ $\mu$ s can be measured with an RBW of 1 MHz with corresponding increases in the RBW for faster frequency ramp rates. For more information see "RBW influence on peak or mean power measurement of pulsed signals" [i.30].

Video bandwidth:	$VBW \geq RBW$
Detector mode:	Peak or auto peak detector
Display mode:	Max. Hold
Average Time:	Larger than one EUT signal repetition time (see annex C)
Sweep time:	Measurement time $\times$ number of measurement points

NOTE 2: As an alternative to the above sweeptime setting, the sweeptime could be used according to the automatic setting of the spectrum analyser and then the maxhold trace mode should be measured for a time of at least sweeptime  $\geq$  signal repetition time  $\times$  measurement points.

The peak power to be considered is the maximum value recorded.

### 5.3.3.4 Peak e.i.r.p. Method with an RMS Power Meter

The RMS power meter shall be connected to the test antenna (see clause B.2.2.5).

The measurement time shall be sufficiently long to cover at least the EUT signal repetition time (see annex C).

The peak power is obtained by dividing the mean power measured by the average power meter with the duty cycle measured according to clause 5.11, see also formula (11).

$$\text{Peak Power [W]} = \frac{\text{Measured Mean Power [W]}}{\text{Duty Cycle}} \quad (11)$$

### 5.3.3.5 Peak e.i.r.p. method with a Peak Power Meter

The peak power meter shall be connected to the test antenna (see clause B.2.2.5).

The measurement time shall be sufficiently long to cover at least the EUT signal repetition time (see annex C).

## 5.3.4 Peak e.i.r.p. Spectral Density

### 5.3.4.1 Description

The maximum peak e.i.r.p. spectral density contained within a 50 MHz bandwidth.

For the peak power spectral density measurements there are two different measurement methods available. While the method in clause 5.3.4.2 applies generally, the method in clause 5.3.4.3 applies only if there is only one spectral line in 50 MHz bandwidth at one time and the bandwidth of the spectral line is smaller than the smallest RBW used for the measurements.

### 5.3.4.2 Peak e.i.r.p. Spectral Density, General Method

When using resolution bandwidths below 50 MHz, this method overestimates the peak power result for most UWB signals due to the worst-case correction factor (see formula (12)). However, it is the simplest and most general measurement method.

NOTE 1: If only one spectral line per 50 MHz occurs and those lines are narrower than the available resolution bandwidth, the method in clause 5.3.4.3 is an equivalent measurement method that avoids the correction factor. Manufacturers with EUTs that satisfy these conditions may use the equivalent method instead of the one outlined in this clause.

The spectrum analyser shall be connected to the test antenna (see clause B.2.2.5).

When measuring maximum peak power from the EUT, the spectrum analyser used shall be configured as follows (an overview of this procedure is provided in the flowchart in figure 7) unless otherwise stated in the related standard:

Start frequency:	Lower edge of the permitted range of operation (see related standard). If nothing is specified in the related standard the pre-scan method (annex E) should be used
Stop frequency:	Upper edge of the permitted range of operation (see related standard). If nothing is specified in the related standard the pre-scan method (annex E) should be used

NOTE 2: For EUT covered by the EC Decision 2019/785/EC of UWB [i.5] the measurement is only performed at the frequency of the maximum mean power spectral density as recorded under clause 5.3.2.2, a specific flowchart is shown in figure 8.

Resolution Bandwidth:	Bandwidth equal or greater than 3 MHz and less or equal than 50 MHz
-----------------------	---

NOTE 3: It is recommended to use the highest available bandwidth for the signal to be measured because choosing a lower bandwidth could lead to an overestimate of the peak power.

Video Bandwidth:	Not less than the resolution bandwidth
Detector Mode:	Peak
Display Mode:	Max. Hold

Wait for each measurement until the reading in the display is stable (this can be assumed to be achieved if a further increase of time for the max hold measurement will not further change the result anymore).

When the measurements have been performed using a lower bandwidth than 50 MHz, the following correction factor (see formula (12)) shall be added to the measured value before comparison with the peak power limits given in the related standard:

$$\text{Corr}_{\text{dB}} = 20 \times \log_{10} \left( \frac{50 \text{ MHz}}{\text{RBW}_{\text{used}} [\text{MHz}]} \right) \quad (12)$$

The measurement results shall be recorded and shall be assessed against the peak power spectral density limits in the related standard.

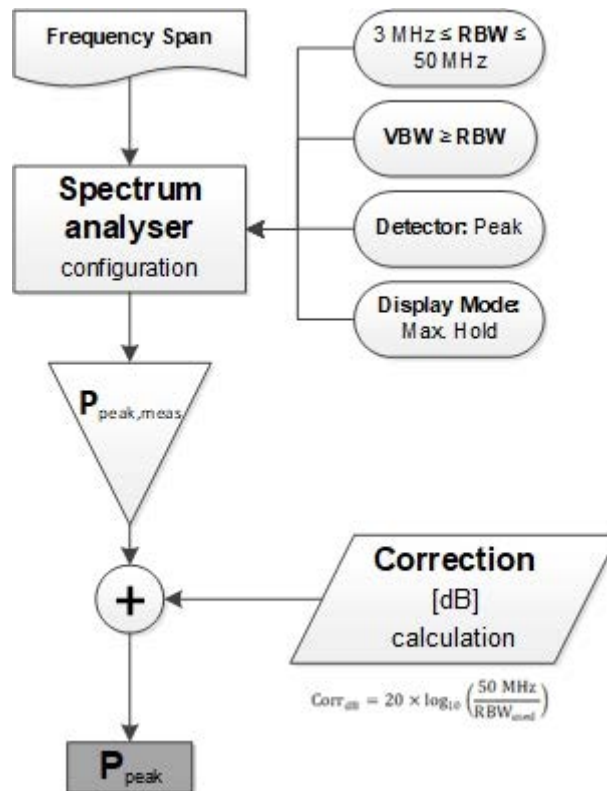

Figure 7: Test Procedure for Peak Power Measurement; General Method

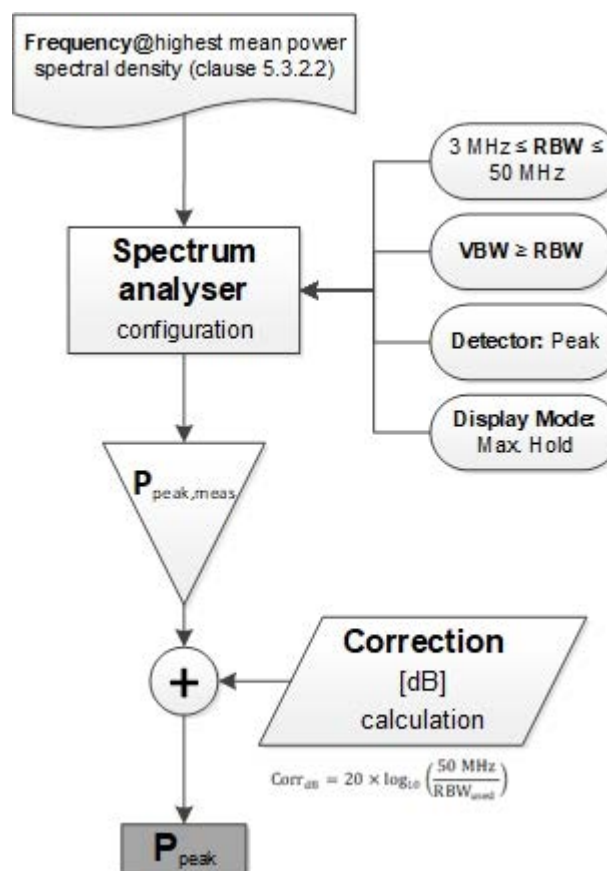

Figure 8: Test Procedure for Peak Power Measurement at the highest mean power spectral density emission

### 5.3.4.3 Peak e.i.r.p. Spectral Density, Sparse Spectral Line Method

#### Restriction:

This method can only be applied, if there is only one spectral line in 50 MHz bandwidth at one time and the bandwidth of the spectral line is smaller than the RBW used for the measurements.

#### EXAMPLES:

- Pulse signal with PRF > 50 MHz and bandwidth of spectral lines < RBW used for measurement.
- Stepped-frequency and FMCW signals with bandwidth of spectral lines < RBW used for measurement. The distance of the spectral lines may be smaller than 50 MHz, if only one spectral line is emitted at one time.

The spectrum analyser shall be connected to the test antenna (see clause B.2.2.5).

When measuring maximum peak power from the EUT, the spectrum analyser used shall be configured as follows, unless otherwise stated in the related standard:

Start frequency:	Lower edge of the permitted range of operation (see related standard). If nothing is specified in the related standard the pre-scan method (annex E) should be used
Stop frequency:	Upper edge of the permitted range of operation (see related standard). If nothing is specified in the related standard the pre-scan method (annex E) should be used
Resolution Bandwidth:	Maximum available bandwidth equal or greater than 3 MHz and less or equal 50 MHz
Video Bandwidth:	Not less than the resolution bandwidth
Detector Mode:	Peak
Display Mode:	Max. Hold

To validate if the restriction described is fulfilled the measurement procedure shall be done with two different resolution bandwidths. The measurement result shall be the same independent of the RBW used.

The measurement results shall be recorded and shall be assessed against the peak power spectral density limits in the related standard.

## 5.4 Other Emissions (OE)

UWB transmitters emit very low power radio signals, comparable with the power of spurious emissions from digital and analogue circuitry within the operating frequency range.

If it can be clearly demonstrated based on test procedures specified in the related standard (or based on annex D) that an emission from the (Ultra Wide Band) radio device is not the (Ultra Wide Band) emission identified in clause 5.3 (e.g. by disabling the radio device's (UWB) transmitter or disconnecting and terminating, internally or externally the antenna of the device) or it can clearly be demonstrated that it is impossible to differentiate between other emissions (OE) and the UWB transmitter emissions (see clause 5.3), then that emission or aggregated emissions shall be considered against the emission limits defined in the harmonised standard that applies to the OE source.

## 5.5 TX Unwanted Emissions (TXUE)

### 5.5.1 Description

TX Unwanted Emissions (TXUE) are emissions on frequencies outside the operating frequency range (OFR). TXUE include harmonic emissions, parasitic emissions, intermodulation products and frequency conversion products related to the RP emissions. TXUE can be split into out-of-band emissions and spurious emissions (see figure 9).

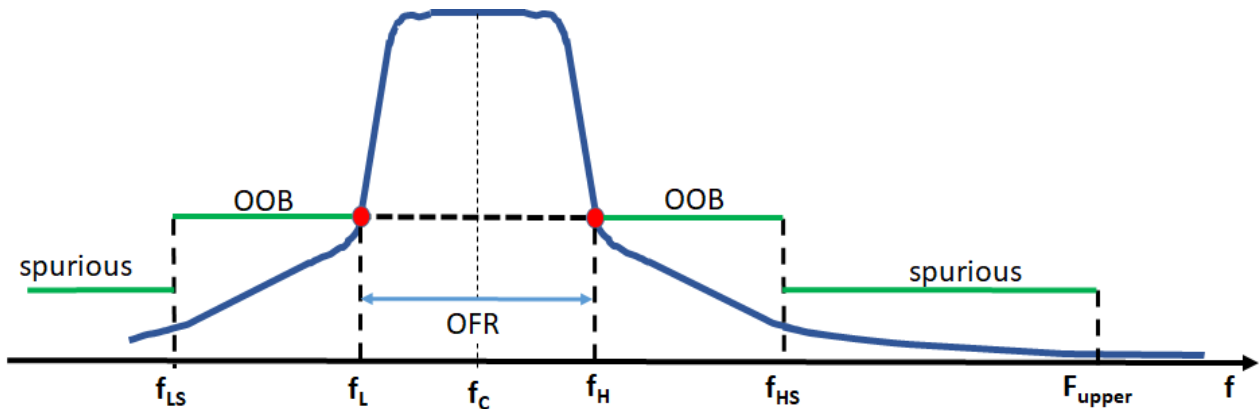

**Figure 9: Overview OOB/spurious, depending on OFR**

The relevant parameters to determine the OOB and spurious domain can be calculated based the measured values  $f_H$  and  $f_L$  from clause 5.2 and on specified values  $X_{TXUE}$  (in %) from the centre frequency of the OFR:

- Calculation centre frequency of the OFR (13):

$$f_C = \left( \frac{f_L + f_H}{2} \right) \quad (13)$$

- Operating frequency range (see clause 5.2), calculated with (14):

$$OFR = f_H - f_L \quad (14)$$

- Calculation  $f_{LS}$  (low boundary between spurious and OOB domain), see (15):

$$f_{LS} = f_C - \left( \frac{X_{TXUE} [\%]}{100\%} \times OFR \right) \quad (15)$$

- Calculation  $f_{HS}$  (high boundary between spurious and OOB domain), see (16):

$$f_{HS} = f_C + \left( \frac{X_{TXUE} [\%]}{100\%} \times OFR \right) \quad (16)$$

NOTE 1: The dimension for the frequencies and bandwidths in the above formulas needs to be equal, e.g. MHz.

For wideband and Ultra Wide Band systems, the boundary value ( $X_{TXUE}$  (in %)) can vary and will be provided in the related harmonised standard. Unless otherwise specified in the related standard,  $X_{TXUE}$  shall be set to 250 % of OFR.

NOTE 2: According to ERC/REC 74-01 [i.9], and Recommendation ITU-R SM.329-12 [i.10], the boundary between the out-of-band and spurious domains is  $\pm 250\%$  of the Operating Frequency Range (OFR) from the centre frequency of the emission.

## 5.5.2 Limits for the TX Unwanted Emission

The limits for the OOB-domain and spurious domain below shall apply unless otherwise specified in the related standard.

**Table 2: Spurious emissions limits in line with ERC/REC 74-01 [i.9]**

Frequency range	Limit values for TXUE (note)
$87,5 \text{ MHz} \leq f \leq 118 \text{ MHz}$	-54 dBm/100 kHz
$174 \text{ MHz} \leq f \leq 230 \text{ MHz}$	-54 dBm/100 kHz
$470 \text{ MHz} \leq f \leq 694 \text{ MHz}$	-54 dBm/100 kHz
otherwise in band $30 \text{ MHz} \leq f < 1\,000 \text{ MHz}$	-36 dBm/100 kHz
$1\,000 \text{ MHz} \leq f \leq F_{\text{upper}}$ (see table 3)	-30 dBm/1 MHz

NOTE: Not applicable for RP emissions within the OFR.

**Table 3: Lower and upper frequency for the spurious emissions test based on the EUT OFR in line with ERC/REC 74-01 [i.9]**

Fundamental frequency range defined by $f_L$ and $f_H$ (note 2)	Frequency range for measurements	
	Lower frequency ( $F_{\text{LOWER}}$ ) (note 3)	Upper frequency ( $F_{\text{UPPER}}$ )
300 - 600 MHz	30 MHz	3 GHz
600 MHz - 5,2 GHz	30 MHz	5 <sup>th</sup> harmonic (note 1)
5,2 - 13 GHz	30 MHz	26 GHz
13 - 150 GHz	30 MHz	2 <sup>nd</sup> harmonic (note 1)
150 - 300 GHz	30 MHz	300 GHz

NOTE 1:  $F_{\text{UPPER}}$  is the stated harmonic of  $f_H$  (the upper edge of the OFR, which is measured in clause 5.2).  
 NOTE 2:  $F_{\text{LOWER}}$  has to be selected based on  $f_L$  and  $F_{\text{UPPER}}$  based on  $f_H$  ( $f_L$  and  $f_H$  can be measured according to clause 5.2); for receive only devices  $f_H$  and  $f_L$  of the related EUT/companion device shall be used.  
 NOTE 3: For EUT operating below 300 MHz the spurious emissions limits below 30 MHz shall be specified in the related standard.

## 5.5.3 General for Conformance Test for TX Unwanted Emission

### 5.5.3.1 General

The following conformance test shall be used for TX unwanted emissions (OOB and spurious emissions) if not otherwise specified in the related standard.

The conformance test shall be performed in two steps:

**Step 1:** pre-scan with peak detector (see clause 5.5.3.2).

**Step 2:** if necessary, RMS measurement (see clause 5.5.3.3).

NOTE: The split in two steps is done because: a complete scan with RMS could take a long time. The measurement with peak detector is an "overestimation" of the emission and is only to find the frequencies with the highest emissions.

### 5.5.3.2 Step 1: Measurement with Peak Detector

The spectrum analyser shall be connected to the test antenna (see clause B.2.2.5).

The following spectrum analyser settings shall be used:

For TXUE measurement below OFR

Start frequency:  $F_{\text{LOWER}}$

Stop frequency:  $f_L$



For TXUE measurement above OFR

Start frequency:  $f_H$   
 Stop frequency:  $F_{UPPER}$

NOTE 1: There could be a need to split the measurement into different frequency ranges depending on the measurement set-up (e.g. external mixers, bandwidth of antennas and waveguides, RBW).

For both measurements:

Resolution BandWidth (RBW):

- $\geq 100$  kHz between 30 MHz and 1 GHz
- $\geq 1$  MHz above 1 GHz

Video BandWidth (VBW) Equal or greater than RBW

Detector mode: Peak

Trace mode: Max hold

Sweep time: Wait for each measurement until the reading in the display is stable

The number of measurement points shall be at least equal or higher than the span of the spectrum analyser divided by the RBW.

NOTE 2: The peak detector is sensitive to corruption by events occurring only once or for a very small amount of time by different devices than the EUT.

NOTE 3: If the signal repetition of the EUT is known the measurement time per measurement point is equal or larger of the signal repetition time.

#### Assessment of step 1:

Compare the measurement results with the limit (see related standard and table 2) and record the frequencies where the limit is exceeded. For these frequencies go to Step 2 (clause 5.5.3.3).

#### 5.5.3.3 Step 2: RMS Measurement

The spectrum analyser shall be connected to the test antenna (see clause B.2.2.5).

Set the spectrum analyser to zero span mode.

Resolution bandwidth (RBW):

- 100 kHz between 30 MHz and 1 GHz
- 1 MHz above 1 GHz

Video bandwidth (VBW): Equal or greater than RBW

Detector mode: Peak

Trace mode: Clear write

Averaging time: Burst duration

NOTE: See definition of continuous transmissions, burst transmission and burst duration in annex C.

Sweep time: Burst duration

- a) Set the spectrum analyser to the first recorded frequency from step 1 (clause 5.5.3.2)
- b) Measure and record the spurious emission value over the sweep time

- c) Calculate the RMS value over the burst duration, using the post processing capability (e.g. RMS time domain power) function of the spectrum analyser
- d) Compare the calculated result with the limit (see related standard and table 2)
- e) Repeat b) - d) for all frequencies from step 1

The measurement results shall be recorded and shall be assessed against limits in table 2 or the limits in the related standard.

## 5.6 Total Radiated Power (TRP)

### 5.6.1 Description

The Total Radiated Power of the EUT is the integration of the time-averaged power flux density  $S$  of the EUT emissions across the entire spherical surface enclosing the EUT.

Measuring the electric field strength, the average power flux density is given by (17):

$$S = \frac{|E_{\text{RMS}}|^2}{Z_{F0}} \quad (17)$$

Where:

- $Z_{F0} = 120\pi\Omega$  represents the wave impedance of free space.

The RMS value of the field strength can be obtained using (18):

$$E_{\text{RMS}} = \frac{|E|}{\sqrt{2}} \quad (18)$$

Where:

- $|E|$  is the amplitude of the electric field.

Using a spectrum analyser, the power flux density is given by (19):

$$S = \frac{P_r}{A_r} \quad (19)$$

Where:

- $P_r$  is the radiated power of the EUT in a certain direction; and
- $A_r$  is the effective area of the receiving antenna.

The Total Power is then given by (20), see figure 10:

$$\text{TRP} = \int_{\theta=0}^{\pi} \int_{\phi=0}^{2\pi} S \times r^2 \times \sin(\theta) \, d\theta \, d\phi \quad (20)$$

Where:

- $r$  is the radius of the sphere
- $\theta$  is the elevation angle
- $\phi$  is the azimuth angle

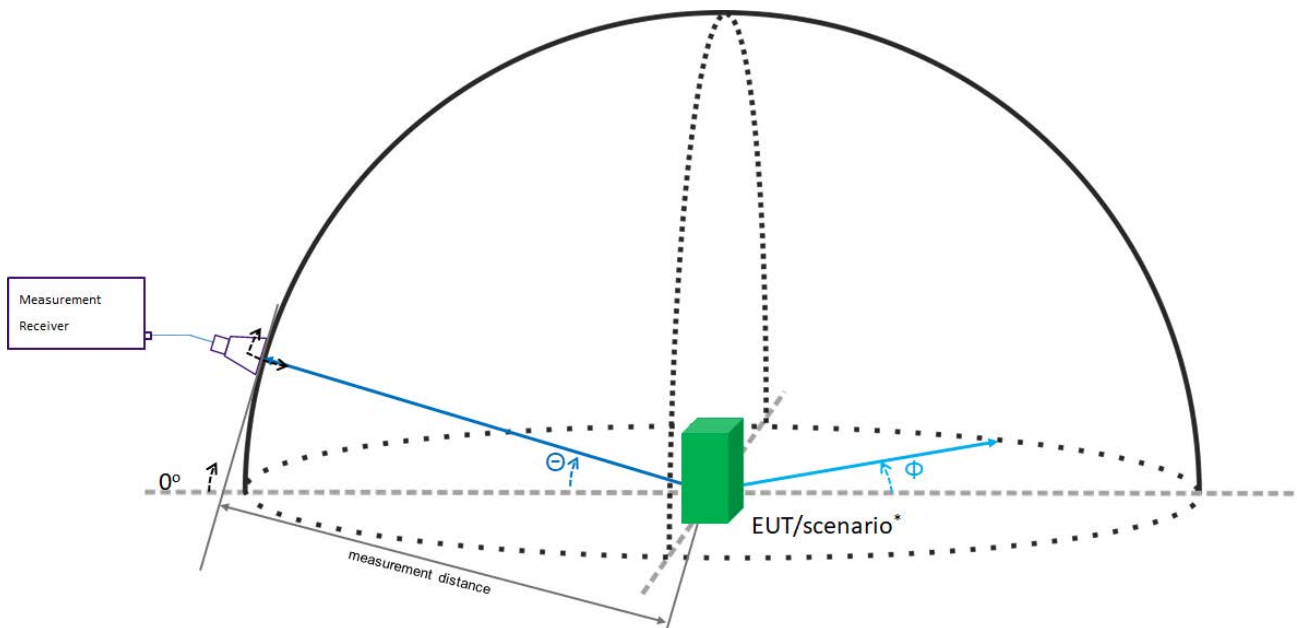

\*EUT/scenario: could be a single device or a complex scenario (e.g. indirect emissions, see clause 5.7).

**Figure 10: Azimuth and Elevation angle definitions**

## 5.6.2 Conformance Test

### 5.6.2.1 General

The requirements shall be calculated (see equation (20)) based on the recorded radiated mean e.i.r.p. spectral density measurement from clause 5.3.2. for each point on the sphere around the EUT. The angular steps  $\Delta\Theta$  and  $\Delta\Phi$  are specified in the related standard.

The radiated power values are required to be recorded for the full half or sphere around the EUT.

**NOTE:** If the assessment is over the half or full sphere then it is related to the specification of the scenario (see also indirect emissions clause 5.7) in the related standard.

### 5.6.2.2 TRP Conformance Assessment in steps:

The spectrum analyser shall be connected to the test antenna (see clause B.2.2.5).

**Step 1:** Consider the test scenario of the EUT in related standard. If no test scenario is specified in the related standard, a set-up based on figure 10 shall be realized. For the measurement distance a value of 3 m shall be used.

**NOTE 1:** For a full spherical test the test could be split into two "half" spherical assessment. After the first half spherical test the EUT device could be turned by 180° in the horizontal plane (see figure 10).

**Step 2:** Start with the first emission measurement at the point of the sphere where  $\Theta$  (elevation angle) and  $\Phi$  (azimuth angle) are both specified as 0. For the emission measurement use the same mean e.i.r.p. spectral density conformance test (see clause 5.3.2) as specified in the related standard for the RP or indirect emission test (see clause 5.7).

The measurement result shall be recorded.

**Step 3:** Increase one angle by the  $X^\circ$ . The value for  $X$  is given in the related standard. If no value for  $X$  is provided in the related standard, then the value of 15° (see 2019/785/EC [i.5]) shall be used.

**Step 4:** Measure the emission as per step 2.

Step 5: Step 3 and step 4 shall be repeated until the complete emissions values around the EUT (see step 1) are recorded.

Step 6: Integrate all recorded measurement results, see formula (21):

$$\text{TRP} = \int_{\Theta=0}^{\pi} \int_{\Phi=0}^{2\pi} \frac{P_{\Theta,\Phi}}{A_r} \times r^2 \times \sin(\Theta) \, d\Theta \, d\Phi \quad (21)$$

Where:

- $P_{\Theta,\Phi}$  measurement (recorded) at one point of the sphere depending  $\Theta$  and  $\Phi$
- $r$  is the radius of the sphere/measurement distance
- $\Theta$  is the elevation angle
- $\Phi$  is the azimuth angle
- $A_r$  is the effective area of the receiving antenna

Step 7: Compare the TRP result out of (21) with the requirement in the related standard.

NOTE 2: If during the radiated mean e.i.r.p. spectral density or indirect emission assessment of the EUT all results will be recorded and the requirement for the angle steps for these test is smaller or similar to the TRP angle requirements, the results can be used to the TRP assessment based on formula (21). In this case the angular steps of the radiated mean e.i.r.p. spectral density or indirect emission assessment is used (see clause B.4.1.1).

## 5.7 Indirect Emissions

### 5.7.1 Description

Indirect emissions are radiated in all directions out of a specified scenario (see figure 11), including direct emissions from the housing/structure of the equipment and emissions reflected or passing through a media under inspection or through a scenario. This requirement is also named an exterior limit or undesired emissions.

The indirect emissions measured outside a specified scenario during the transmit mode of the EUT are the sum of:

- Reflections of the radiated power from the transmitter (see clause 5.3) within the scenario.
- Other Emissions (OE) from the transmitter, receiver and other analogue or digital circuitry (see clause 5.4).
- TX Unwanted Emissions (TXUE) from the transmitter (out-of-band and spurious domain, see clause 5.5).

The related limit of the indirect emission and the related source for the requirement (RP, TXUE; OE) and the related test scenario shall be specified in the related standard.

Based on the possible different levels of emission limits it could be necessary that a conformance assessment has to be performed in two steps, see annex D.

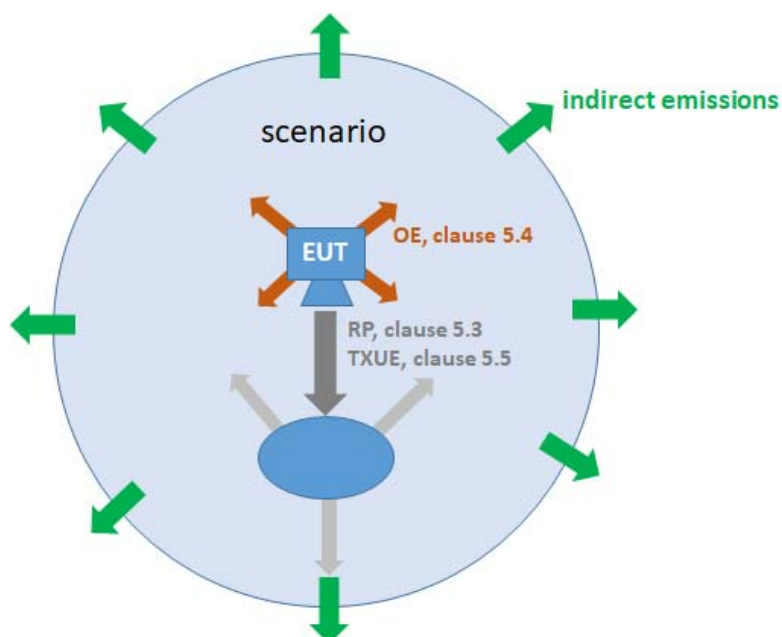

**Figure 11: Indirect emissions**

- For GPR/WPR case ( see ECC/DEC(06)08 [i.11]): Indirect emissions are all emissions radiated in all directions above the ground from the GPR/WPR equipment, see figure 12.

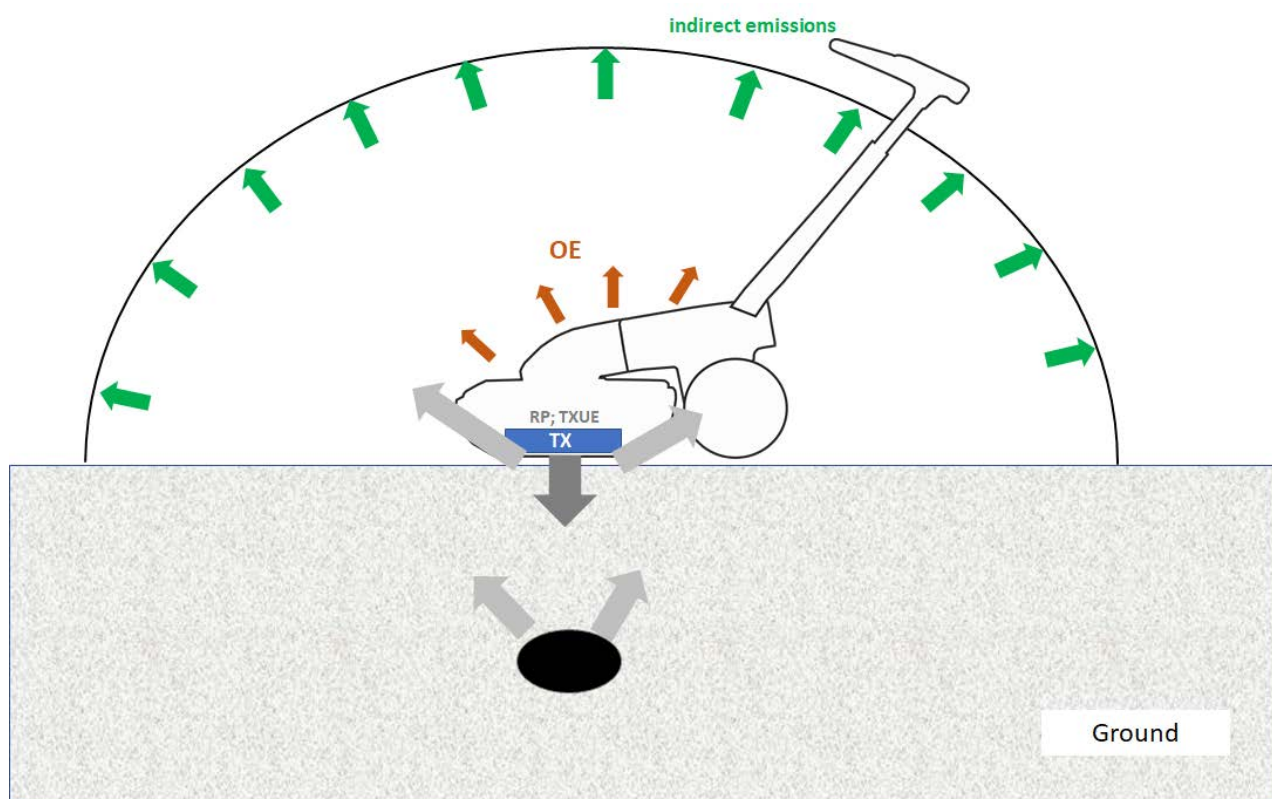

**Figure 12: Indirect emissions for a GPR scenario**

- For Tank Level Probing Radar (TLPR, see ETSI EN 302 372 [i.12] or ETSI TR 102 347 [i.25]): Indirect emissions are all emissions radiated in all directions outside a given test tank with an installed EUT, see figure 13.

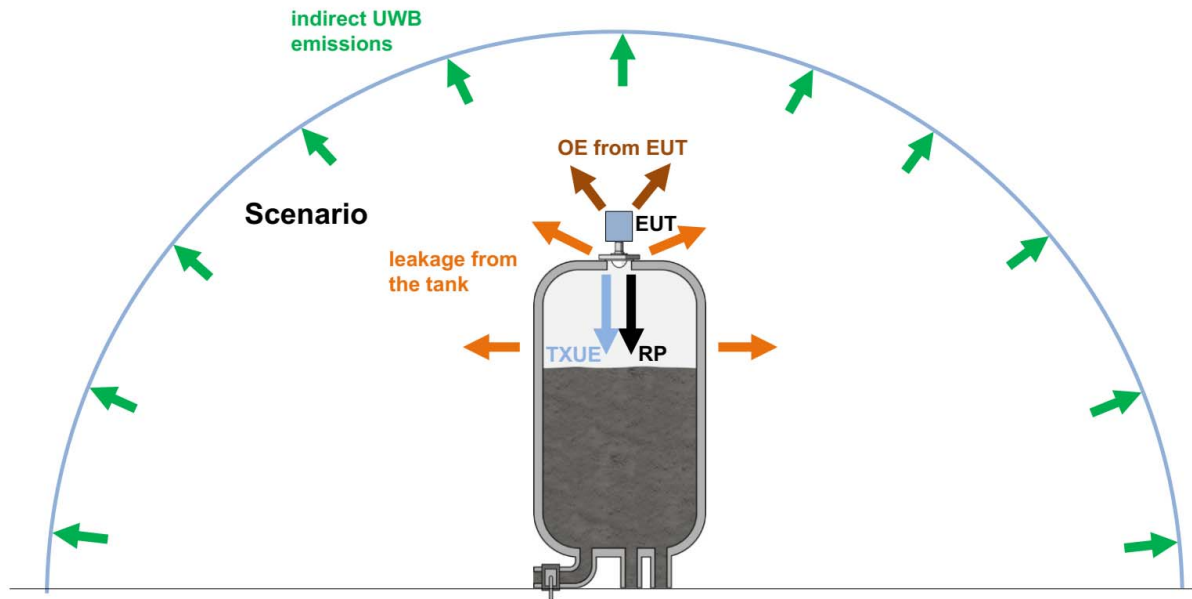

**Figure 13: Illustration of indirect (UWB) emissions for Tank Level Probing Radar (TLPR)**

- For Level Probing Radar (LPR, see ECC/DEC/(11)02 [i.6] or ECC Report 139 [i.26]): Indirect emissions are all emissions radiated in all directions outside the LPR scenario. Conformance of indirect emissions can also be fulfilled by measuring in boresight direction following the half-sphere-concept according to ETSI EN 302 729-1 [i.31], see figure 14.

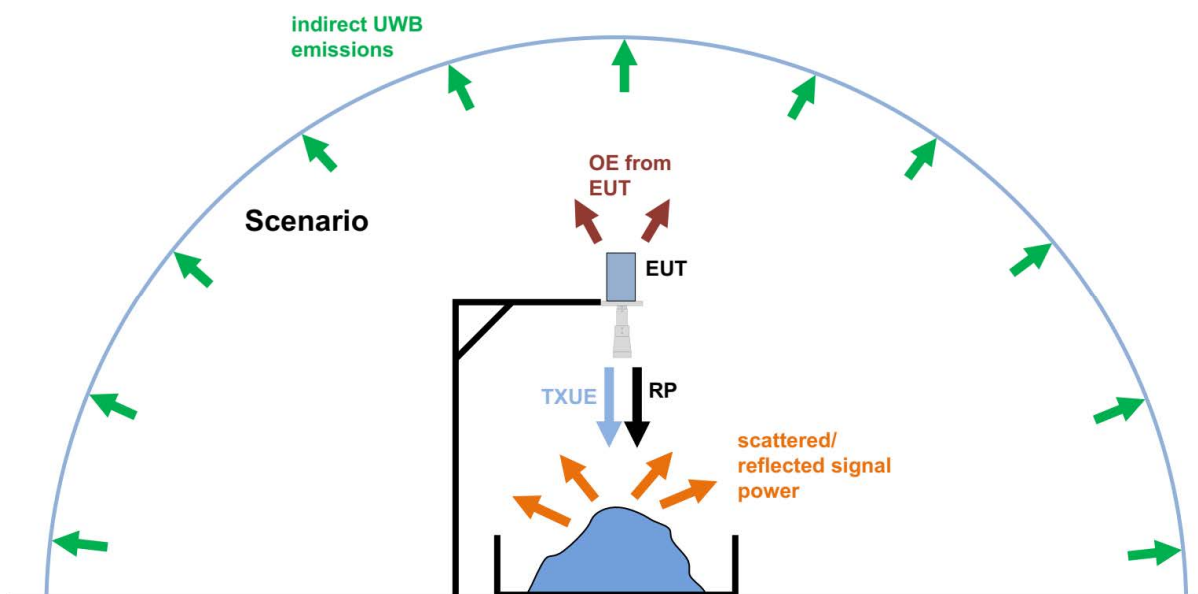

**Figure 14: Illustration of indirect (UWB) emissions for Level Probing Radar (LPR)**

- For contact based material sensing devices (see ECC/DEC/(07)01 [i.4]): Indirect emissions are all emissions radiated in all directions outside a given scenario (e.g. sensor on a test wall structure).

One example could be a wall scanning device, see figure 15.

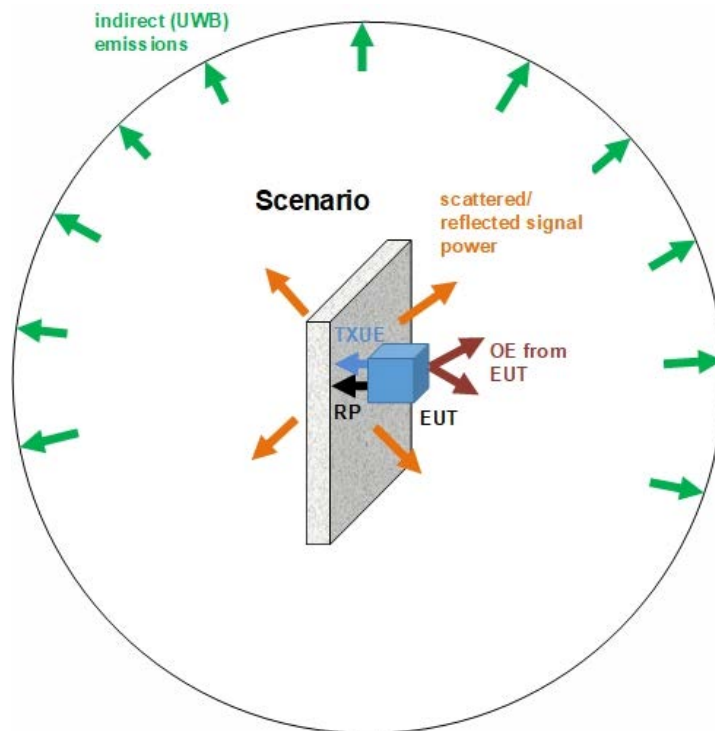

**Figure 15: Illustration of indirect emissions for wall scanning scenario**

- For non-contact based material sensing devices (see ECC/DEC/(07)01 [i.4]): Indirect emissions are all emissions radiated in all directions outside a given scenario. The UWB transmitter is only switched on when in close proximity with the investigated material and the UWB transmitter is directed into the direction of the material under investigation (e.g. manually, by using a proximity sensor or by mechanical design).

One example for such scenario could be a security scanning application, see figure 16.

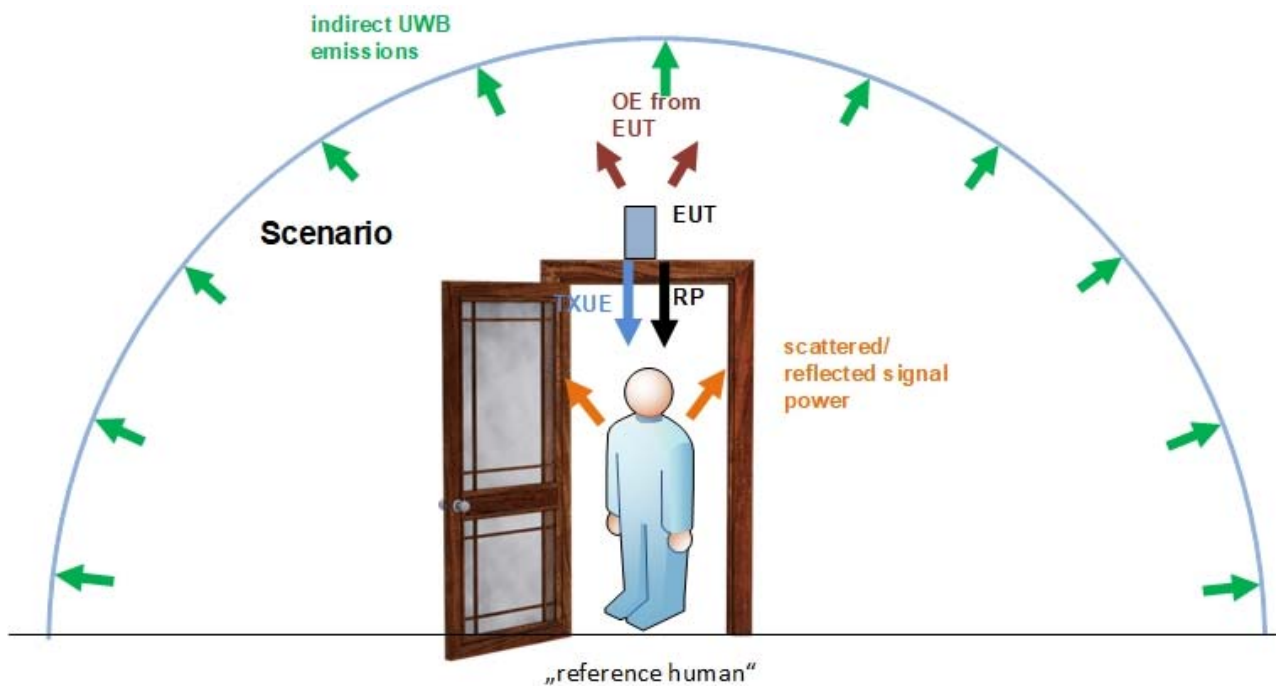

**Figure 16: Illustration of indirect emissions for a security scanning scenario**

- For in-vehicular applications (see ECC/DEC/(06)04 [i.3], annex A.1.2): Indirect emissions are all emissions radiated outside the vehicle scenario, see figure 17 and related standard.

Short explanation:

- Above the horizontal plane the indirect emissions limit outside the vehicle: -53,3 dBm/MHz
- Below the horizontal plane: -41,3 dBm/MHz

NOTE: A UWB device inside a vehicle is allowed to transmit up to -41,3 dBm/MHz if the exterior limit/indirect emission requirement is fulfilled, see the related standard.

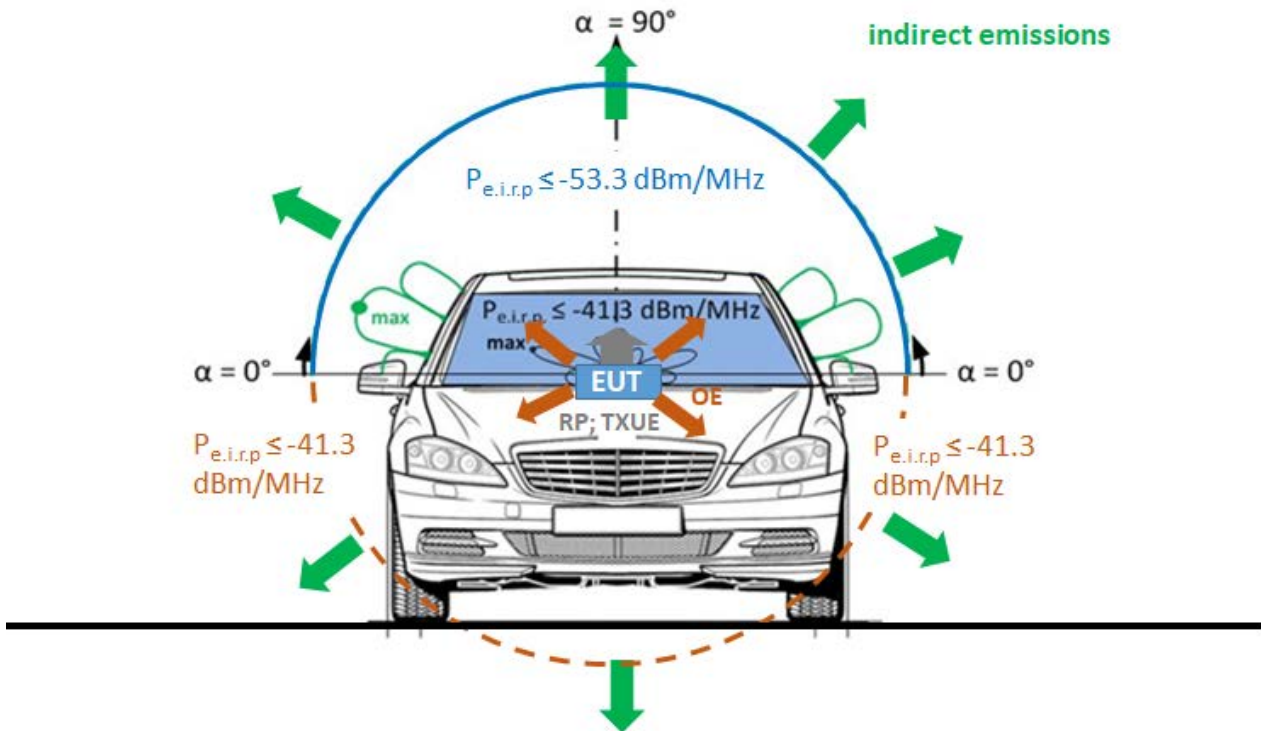

Figure 17: Illustration of indirect emissions for a scenario with EUT inside a vehicle

## 5.7.2 Guidance for Conformance Test

The conformance test is in close relation with the use-cases scenario and the wanted technical performance criteria. Therefore, the conformance test shall be specified in the related standard, see overview in clause 4.1.

For the power measurement the related procedure based on the requested parameter (e.g. mean or peak power) shall be chosen, see clause 5.3.

## 5.8 Transmit Power Control

### 5.8.1 Description

Transmit Power Control (TPC) is a mechanism to be used to ensure an interference mitigation on the aggregate power from a large number of radio devices. The TPC mechanism shall provide the full range from the highest to the lowest power level of the radio device ETSI TR 103 181-2 [i.14]. This could be realized within one step or with an adaptive mechanism. Sometimes this mitigation technique also names as Adaptive Power Control (APC).

### 5.8.2 Guidance for Conformance Test

For TPC mitigation the conformance test is dependent on the wanted technical performance criteria (e.g. RX-requirements) and the use-case of the EUT. Therefore, the conformance procedure for TPC mitigation shall be specified in the related standard.



For the power measurement the related procedure based on the requested parameter (e.g. mean or peak power) shall be chosen, see clause 5.3.

## 5.9 Detect and Avoid

### 5.9.1 Description

The detect and avoid mechanism is an active mitigation technique for the protection of sensitive potential victim systems in the vicinity of the UWB device based on a sensing approach including an active reduction of the interference potential if required (see ETSI TR 103 181-2 [i.14] and ETSI TS 102 754 [1]).

This optional mitigation technique is applicable for EUTs considered under ECC/DEC(07)01 [i.4] or ECC/DEC(06)04 [i.3].

### 5.9.2 Limits

#### 5.9.2.1 DAA Parameters

The limits apply for all EUT which implemented Detect and Avoid Mitigation technique for the part(s) of the operating frequency range (see clause 5.2) that overlaps with the DAA frequency ranges (see table 4).

**Table 4: Technical parameters UWB DAA mitigation in line with ECC Report 120 [i.16]**

<b>DAA frequency ranges [GHz]</b>	<b>3,1 - 3,4</b>	<b>3,4 - 3,8</b>	<b>3,8 - 4,8</b>	<b>8,5 - 9</b>
Minimum initial channel availability check time ( $T_{\text{avail\_time\_min}}$ ) [s]	14	5,1		14
Signal test pattern, see ETSI TS 102 754 [1]	clause D.4	clause E.4		clause D.4
$T_{\text{avoid\_max}}$ [s], see ETSI TS 102 754 [1]	150	<ul style="list-style-type: none"> <li>• VoIP: 2</li> <li>• Web surfing: 15</li> <li>• Sleep mode: 60</li> <li>• Multimedia broadcasting: 15</li> </ul>		150
<b>Zone 1 for Signal (S) detection level <math>S &gt; A</math></b>				
Maximum mean e.i.r.p. spectral density [dbm/MHz]	-70	-80	-70	-65
Default Avoidance bandwidth [MHz]	300	200		500
Signal Detection threshold A [dBm]	-38	-38		-61
<b>Zone 2 for Signal (S) detection level <math>A &gt; S &gt; B</math></b>				
Maximum mean e.i.r.p. spectral density [dbm/MHz]	-41,3	-65		-41,3
Default Avoidance bandwidth [MHz]	-	200		-
Signal Detection threshold B [dBm]		-61		
<b>Zone 3 for Signal detection level <math>S &lt; B</math></b>				
Maximum mean e.i.r.p. spectral density [dBm/MHz]	-	-41,3		-
Definitions of the parameters in table 4 can be found in ECC Report 120 [i.16].				

### 5.9.2.2 DAA NIM parameters

**Table 5: Non-Interference Mode (NIM) parameters in the band 3,1 GHz to 9,0 GHz according to ETSI TS 102 754 [1]**

DAA frequency ranges	NIM Power levels (e.i.r.p.)	NIM Power levels (e.i.r.p.) with LDC implemented
3,1 GHz to 3,4 GHz	-70 dBm/MHz average. -36 dBm peak (see note)	-41,3 dBm/MHz average. 0 dBm peak Standard LDC parameters as in [i.3]
3,4 GHz to 3,8 GHz	-80 dBm/MHz average. - 40 dBm peak (see note)	-41,3 dBm/MHz average. 0 dBm peak Standard LDC parameters as in [i.3]
3,8 GHz to 4,2 GHz	-70 dBm/MHz average. -30 dBm peak (see note)	-41,3 dBm/MHz average. 0 dBm peak Standard LDC parameters as in [i.3]
4,2 GHz to 4,8 GHz	-70 dBm/MHz average. -30 dBm peak (see note)	-41,3 dBm/MHz average. 0 dBm peak Standard LDC parameters as in [i.3]
8,5 GHz to 9,0 GHz	-65 dBm/MHz average. -25 dBm peak (see note)	-41,3 dBm/MHz average. 0 dBm peak Standard LDC parameters as in [i.3]
NOTE: Devices fitted with DAA mitigation may operate to the maximum permissible limit of -41,3 dBm/MHz average and 0 dBm peak.		

### 5.9.2.3 DAA test parameters

If nothing different is specified in the related standard, following values for the test parameters shall be used during the conformance tests (see clause 5.9.3):

- $m = 10$
- $n = 5$

## 5.9.3 Conformance Test

### 5.9.3.1 Introduction

In the present clause the test procedure for the DAA test is depicted. The UWB DAA radio device under test shall be verified under normal operational conditions.

The DAA test is split into two main test conditions:

- start-up test with and without victim test signal; and
- in-operation test.

The start-up test verifies the operation of the UWB DAA radio device during the initial start-up when the DAA UWB radio device intends to operate directly in a non NIM. Thus the UWB DAA radio device need to be set in an operational condition in which this is guaranteed. The test verifies that the UWB DAA radio device respects the defined *Minimum Initial Channel availability Check Time*.

The in-operation test is intended to verify the dynamic behaviour of the UWB DAA radio device under test. During this test the UWB DAA radio device under test shall operate in a normal dynamic operational mode.

The radiated test configuration is shown in figure 18 and the conducted test configuration is shown in figure 19.

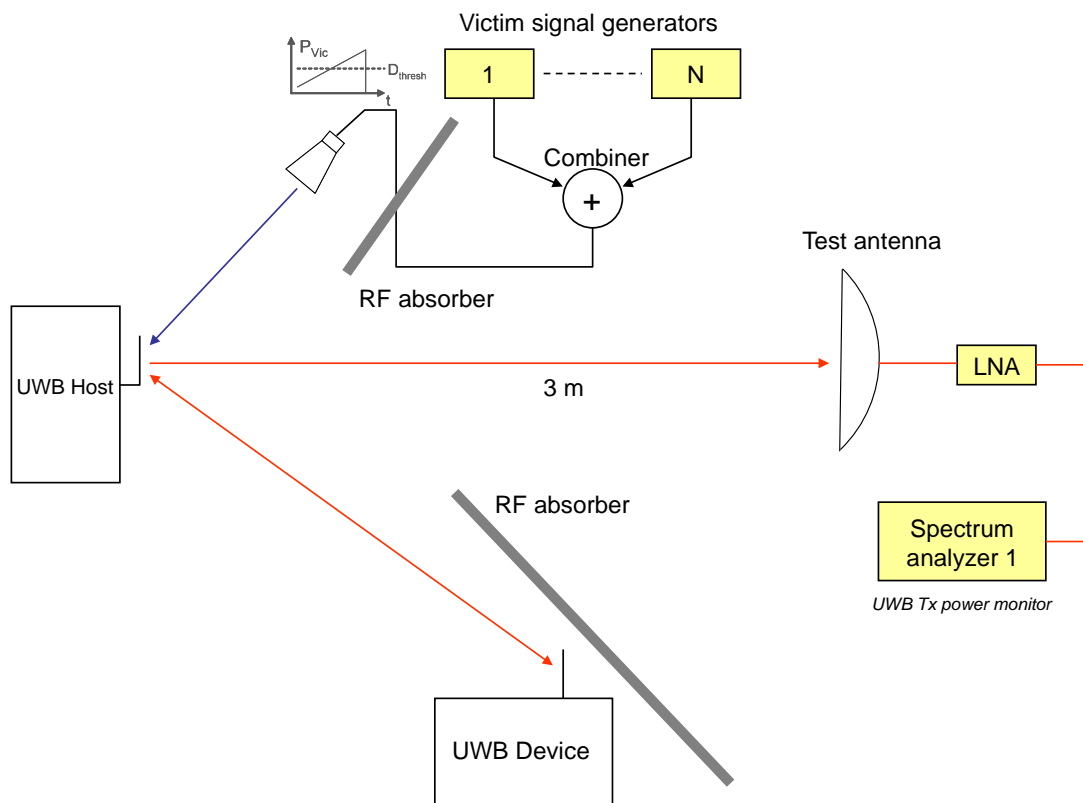

Figure 18: Example Setup for radiated DAA measurements

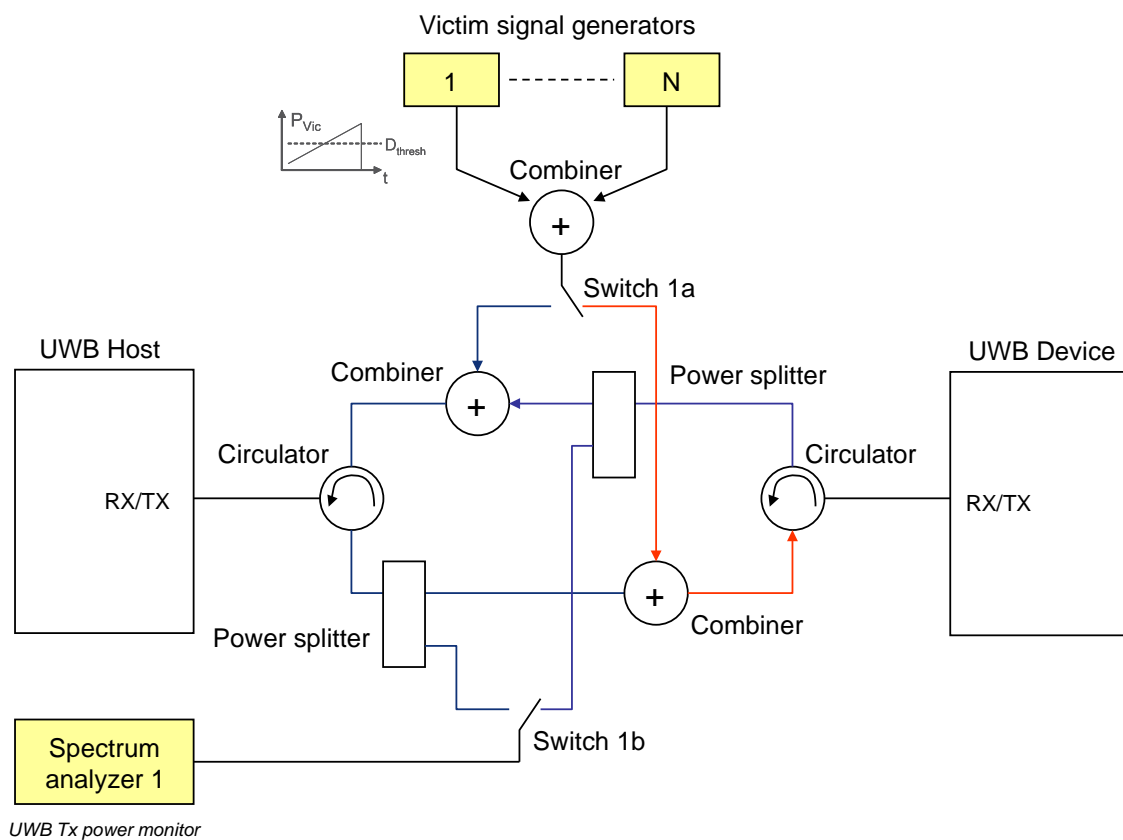

Figure 19: Example Setup for conducted DAA measurements

## 5.9.3.2 Initial Start-Up Test

### 5.9.3.2.1 Start-up Procedure

The clauses below define the procedure to verify the *Minimum Initial Channel Availability Check* by ensuring that the UWB DAA radio device is capable of detecting victim system signals at the beginning and at the end of the *Minimum Channel Availability Check Time*. Furthermore, one initial test shall guarantee that the UWB radio device does not switch out of a NIM operation before the end of the *Minimum Initial Channel Availability Check time*.  $T_{\text{avail\_time\_min}}$

### 5.9.3.2.2 Test without a victim test signal during the *Minimum Initial Channel Availability Check Time*, $T_{\text{avail\_time\_min}}$

Summary:

Verify the UWB DAA radio device will not start transmitting in a non NIM operation before the end of the *Minimum Initial Channel Availability Check Time* when no victim test signal is present. This is illustrated for a radiolocation signal in figure 20.

Pre-test Condition:

- UWB radio device supporting DAA.
- UWB radio device switched off.

Test sequence:

- a) The UWB DAA radio device will be switched off. No signal generator is connected to the test setup or the signal generator is switched off.
- b) The UWB DAA radio device is powered on at  $T_0$ .  $T_1$  denotes the instant when the UWB DAA radio device has completed its power-up sequence ( $T_{\text{power\_up}}$ ), enters into a NIM mode, ready to start the victim signal detection.

**CON-1:** The UWB DAA radio device shall not switch into a non-NIM mode before the end of  $T_{\text{avail\_time\_min}}$  after switch on of the radio device, where the NIM operation is either the LDC mode or the power level defined in relevant harmonised standards for the relevant victim band.

NOTE: Additional verification may be needed to define  $T_1$  in case it is not exactly known or indicated by the UWB DAA radio device. For example,  $T_1$  could be determined by taking into account  $T_{\text{avail\_time\_min}}$  and the instance the device switches to a non-NIM mode in clause 5.9.3.2.2 Test without a victim test signal present.

**CON-2:** A timing trace or description of the observed timing and behaviour of the UWB DAA radio device shall be recorded.

- c) Repeat a) and b) for  $n$  times in a row. The values for  $n$  shall be defined in the relevant harmonised standard.

**CON-3:** CON-1 and CON-2 shall be fulfilled in all  $n$  tests. If one failure occurs go to d). For more than one failure the test has not been passed.

- d) Repeat a) and b) for  $m$  times in a row. The values for  $m$  shall be defined in the relevant harmonised standard.

**CON-4:** CON-1 and CON-2 shall be fulfilled in all  $m$  tests.

- e) End of test.

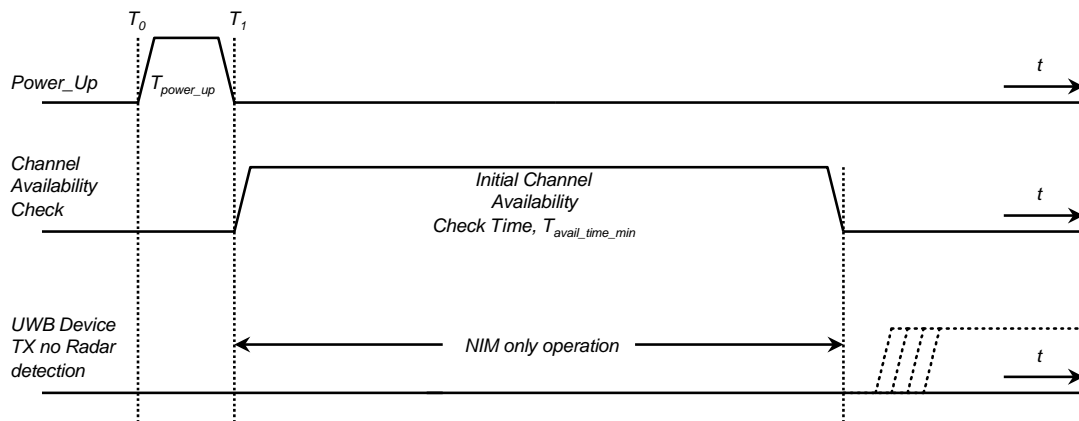

**Figure 20: Example of timing for a radiolocation testing of the Minimum Initial Channel Availability Check Time  $T_{\text{avail\_time}}$ , UWB DAA device intent to operate in a non NIM mode**

### 5.9.3.2.3 Test with a victim test signal at the beginning of the *Minimum Initial Channel Availability Check Time*, $T_{\text{avail\_time\_min}}$

Summary:

Verify the victim signal detection and avoidance capability for the selected UWB operational frequency when a victim signal occurs at the beginning of the *Minimum Initial Channel Availability Check Time*.

Pre-test Condition:

- UWB radio device supporting DAA.
- UWB radio device switched off.

Test Sequence:

- The UWB DAA radio device will be switched off. The signal generator used to generate the test patterns see table 4 will be connected to an antenna of suitable characteristics to permit the UWB DAA radio device to be illuminated with a field equal to the signal detection threshold limit (see table 4) or connected to the corresponding connectors in the case of a conducted measurement setup.
- The UWB DAA radio device is powered on at  $T_0$ .  $T_1$  denotes the instant when the UWB DAA radio device has completed its power-up sequence ( $T_{\text{power\_up}}$ ), enters a NIM mode, ready to start the victim signal detection.
- The victim system test signal will be switched on at  $T_1 + \Delta t$  (with  $\Delta t < 2$  s) with the test pattern (see table 4), timing behaviour and power levels in accordance with table 4.

**CON-1:** The *Minimum initial Channel Availability Check* is expected to commence at  $T_1$  and is expected to end no sooner than  $T_1 + T_{\text{avail\_time\_min}}$  unless a victim signal is detected sooner.

**NOTE:** Additional verification may be needed to define  $T_1$  in case it is not exactly known or indicated by the UWB DAA radio device. For example,  $T_1$  could be determined by taking into account  $T_{\text{avail\_time\_min}}$  and the instance the device switches to a non-NIM mode in clause 5.9.3.2.2 Test without a victim test signal present.

**CON-2:** It shall be recorded if the victim test signal was detected. This can be done by verifying that the UWB DAA radio device is switched into an avoid operation corresponding to the investigated threshold level in the relevant operational band or stays in a corresponding NIM operation. The following avoid operation parameters shall be verified:

- *default avoidance bandwidth* for the victim system service identified and where relevant, see ETSI TS 102 754 [1];

- *optional avoidance mechanisms* identified by the manufacturer for the victim system service identified, see ETSI TS 102 754 [1];
- LDC operational parameter if applicable.

**CON-3:** A timing trace or description of the observed timing and behaviour of the UWB DAA radio device shall be recorded for each avoidance mechanism.

- d) Repeat a) to c) for  $n$  times in a row. The values for  $n$  shall be defined in the relevant harmonised standard.

**CON-4:** CON-1, CON-2 and CON-3 shall be fulfilled in all  $n$  tests. If CON-3 is fulfilled go to f). If one failure occurs go to e). For more than one failure the test has not been passed.

- e) Repeat a) to c) for  $m$  times in a row. The values for  $m$  shall be defined in the relevant harmonised standard.

**CON-5:** CON-1, CON-2 and CON-3 shall be fulfilled in all  $m$  tests.

- f) Repeat b) to e) for each of the relevant victim test pattern (see table 4) depending on the UWB operating frequency range (see clause 5.2) at the threshold levels as defined in table 4.

**CON-6:** A timing trace or description of the observed timing and behaviour of the UWB DAA radio device shall be recorded.

#### 5.9.3.2.4 Test with a victim test signal at the end of the *Minimum Initial Channel Availability Check Time*, $T_{\text{avail\_time\_min}}$

Summary:

Verify the victim signal detection and avoidance capability for the selected UWB operational frequency when a victim signal occurs at the end of the *Minimum Initial Channel Availability Check Time*.

Pre-test Condition:

- UWB radio device supporting DAA.
- UWB radio device switched off.

Test Sequence:

- a) The UWB DAA radio device will be switched off. The signal generator used to generate the test patterns (see table 4) and will be connected to an antenna of suitable characteristics to permit the UUT to be illuminated with a field equal to the threshold detection limit or connected to the corresponding connectors in the case of a conducted measurement setup.
- b) The UWB DAA radio device is powered up at  $T_0$ .  $T_1$  denotes the instant when the UWB DAA radio device has completed its power-up sequence ( $T_{\text{power\_up}}$ ), enters into a NIM mode, ready to start the victim signal detection.

**CON-1:** The *Minimum Initial Channel Availability Check*  $T_{\text{avail\_time}}$  is expected to commence at instant  $T_1$  and is expected to end no sooner than  $T_1 + T_{\text{avail\_time}}$  unless a victim signal is detected sooner.

NOTE: Additional verification may be needed to define  $T_1$  in case it is not exactly known or indicated by the UWB DAA radio device. For example,  $T_1$  could be determined by taking into account  $T_{\text{avail\_time\_min}}$  and the instance the device switches to a non-NIM mode in clause 5.9.3.2.2 Test without a victim test signal present.

- c) The victim system test signal will be switched on at  $T_0$  with the test pattern (see table 4), timing behaviour and power levels in accordance with the relevant harmonised standard.

**CON-2:** It shall be recorded if the victim test signal was detected. This can be done by verifying that the UWB DAA radio device is switched into an avoid operation corresponding to the investigated threshold level in the relevant operational band or stays in a corresponding NIM operation. The following avoid operation parameter shall be verified:

- *default avoidance bandwidth* for the victim system service identified and where relevant, see ETSI TS 102 754 [1];
- *optional avoidance mechanisms* identified by the manufacturer for the victim system service identified, see ETSI TS 102 754 [1];
- LDC operational parameter if applicable.

**CON-3:** A timing trace or description of the observed timing and behaviour of the UWB DAA radio device shall be recorded for each avoidance mechanism.

- d) Repeat a) to c) for  $n$  times in a row. The values for  $n$  shall be defined in the relevant harmonised standard.

**CON-4:** CON-1, CON-2 and CON-3 shall be fulfilled in all  $n$  tests. If CON-3 is fulfilled go to f). If one failure occurs go to e). For more than one failure the test has not been passed.

- e) Repeat a) to c) for  $m$  times in a row. The values for  $m$  shall be defined in the relevant harmonised standard.

**CON-5:** CON-1, CON-2 and CON-3 shall be fulfilled in all  $m$  tests.

- f) Repeat a) to e) for each of the relevant radar test signals for the UWB operational frequency range as defined in the relevant harmonised standard at a level of 10 dB above the defined threshold level given in the relevant harmonised standard and at exactly the threshold levels given in the relevant harmonised standard.

**CON-6:** A timing trace or description of the observed timing and behaviour of the UWB DAA radio device shall be recorded.

### 5.9.3.3 In-Operation Test

#### 5.9.3.3.1 General Points for In-Operation Test

This series of tests evaluates the UWB radio device's response to the presence of different payload types which the victim service may carry. The relevant services are defined in table 4.

In the in-operation test set up the UWB pair will be actively exchanging data under the presence of a victim signal pattern as defined table 4. In this test the *Detect and Avoid time* will be recorded and the corresponding avoidance operation will be verified.

During the test, the existing data link might be disrupted. This should then not lead to an uncontrolled operation but to an operation equivalent to the NIM mode.

Depending on the test pattern definition in the relevant harmonised standards a power ramping of the victim signal might be necessary. An example for that ramping is given in figure 21.

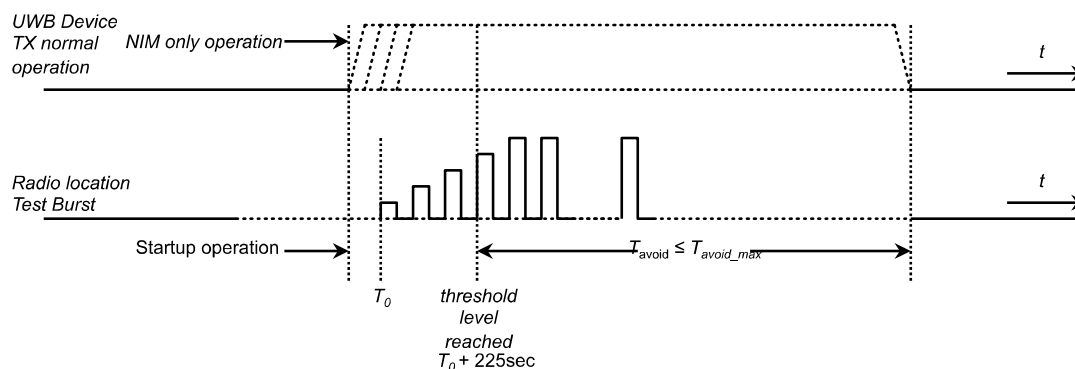

**Figure 21: Example of timing for victim signal in-operation testing of the Detect and Avoid Time, here with increasing Radiolocation test signal**

### 5.9.3.3.2 In-Operation Test Procedure

#### Summary:

The procedure below verifies the victim signal detection and avoidance capability for the selected UWB operational frequency in normal UWB operation using an increasing victim test signal level. In this test the *Detect and Avoid time* and the corresponding avoidance operation will be verified.

#### Pre-test Condition:

- Two UWB radio devices at least one supporting DAA.
- Both UWB radio devices switched on.
- UWB radio device in normal communication mode.

#### Test Sequence:

- a) Both UWB DAA radio devices shall be switched on and in a stable operational mode as defined in relevant harmonised standard. The signal generator used to generate the test patterns given in the relevant harmonised standard will be connected to an antenna of suitable characteristics to permit the UUT to be illuminated with a field equal to the threshold detection limit or connected to the corresponding connectors in the case of a conducted measurement setup.
- b) The victim system test signal will be switched on at  $T_0$  with the test pattern, timing behaviour and power levels in accordance with table 4.

**CON-1:** The measurement of the actual "Detect and Avoid Time"  $T_{\text{avoid}}$  of the EUT is expected to commence at an instant after  $T_0$  as given in the relevant harmonised standard. The actual detect and avoid time of the radio device under test shall be smaller or equal to the Maximum Detect and Avoid time  $T_{\text{avoid\_max}}$  as defined in the relevant standard. The actual Detect and Avoid time  $T_{\text{avoid}}$  of the radio device under test can be negative. The following avoid operations shall be verified:

- *default avoidance bandwidth* for the BWA service identified and where relevant, see ETSI TS 102 754 [1];
- *optional avoidance mechanisms* identified by the manufacturer for the BWA service identified, see ETSI TS 102 754 [1];
- LDC operational parameter if applicable.

**CON-2:** It shall be recorded if the victim test signal was detected before the time instance given in the relevant standard.

- c) Repeat a) and b) for  $n$  times in a row. The values for  $n$  shall be defined in the relevant harmonised standard.

**CON-3:** CON-1 and CON-2 shall be fulfilled in all  $n$  tests, then go to e). If one failure occurs go to d). For more than one failure the test has not been passed.

- d) Repeat a) and b) for  $m$  times in a row. The values for  $m$  shall be defined in the relevant harmonised standard.

**CON-4:** CON-1 and CON-2 shall be fulfilled in all  $m$  tests.

- e) Repeat b) to d) for each threshold given in the relevant harmonised standard.

**NOTE:** Instead of repeating the test for each threshold, continuous testing for the different thresholds can also be performed. Depending on the implemented avoidance strategy, some threshold tests may be redundant, i.e. one test already covers another case.

- f) Repeat b) to e) for each of the relevant victim test pattern for the UWB operating frequency range and threshold levels as defined in table 4.



## 5.10 Listen Before Talk (LBT)

### 5.10.1 Description

Listen Before Talk (LBT) is a mechanism to protect other operating services from interference in the same band.

This mitigation technique is only applicable for EUTs considered under ECC/DEC/(07)01 [i.4].

The LBT function identifies the presence of signals within the band of operation and only allows activation of the UWB emission when no signals are detected.

Figure 22 depicts the basic operation of LBT for non-fixed (mobile/handheld) material sensors. Figure 23 depicts the operation for (quasi) fixed material sensors.

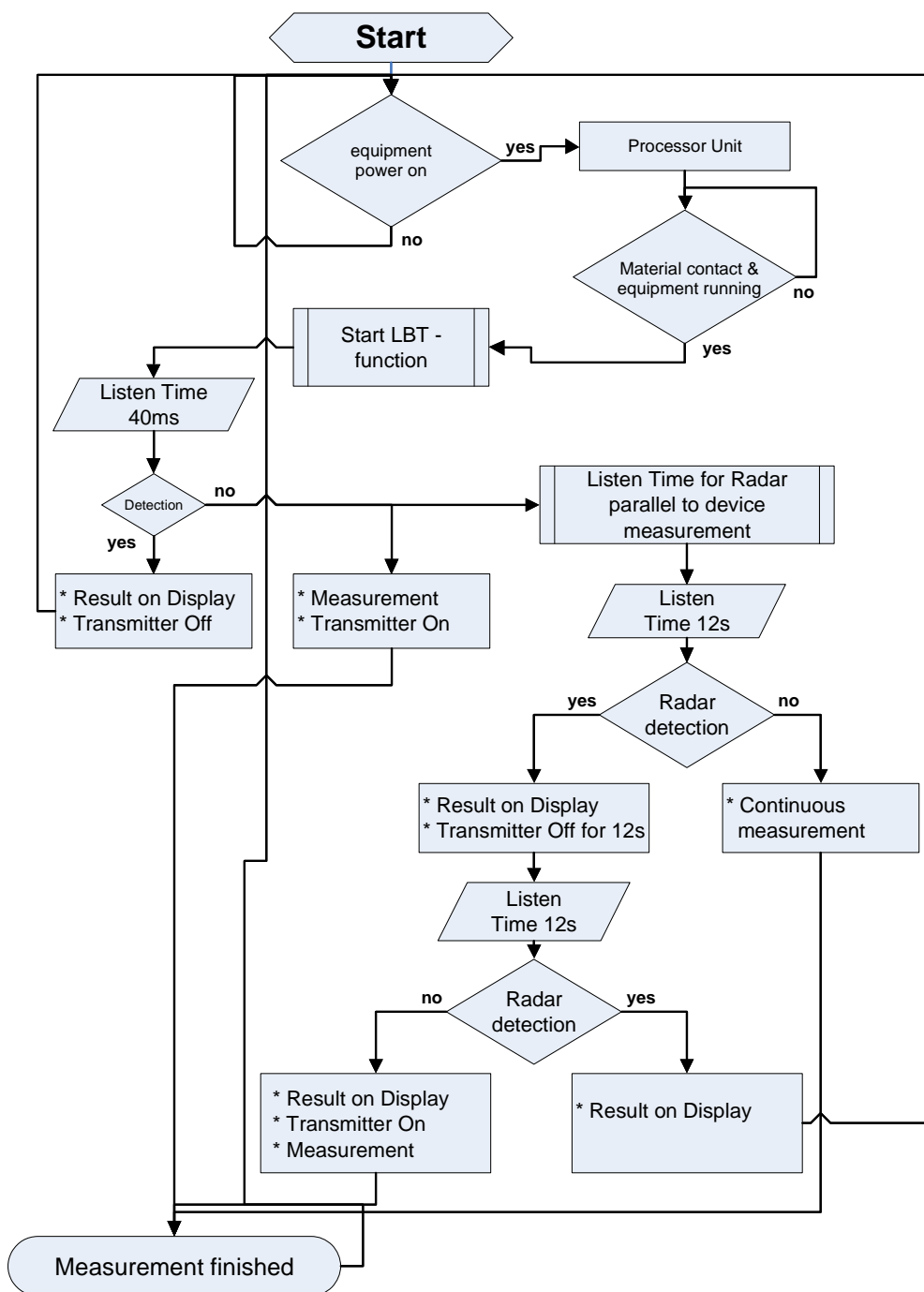

Figure 22: Flow diagram of LBT mechanism for non-fixed (mobile) material sensors

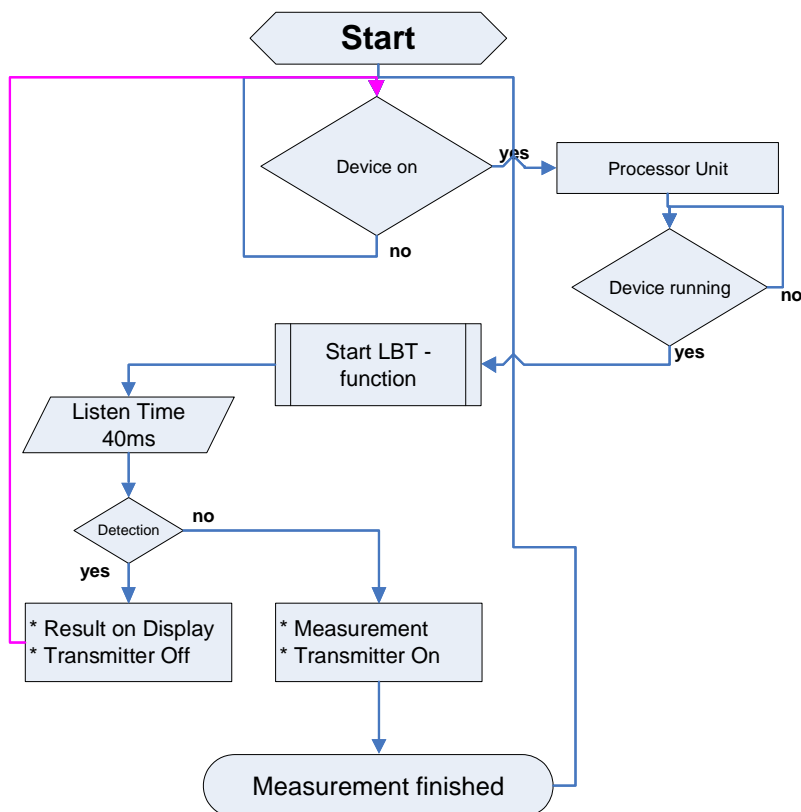

Figure 23: Flow diagram of LBT mechanism for (quasi) fixed material sensors

## 5.10.2 Limits

The LBT mechanism of the UWB receiver shall meet the threshold levels at the EUT as defined in table 6.

In case the UWB equipment covers only part of the frequency range of table 6, the LBT function shall only be implemented for the OFR of the EUT as specified in the related harmonised standard.

The limits given in table 6 shall be measured in the measurement scenarios defined in the related standard. A generic procedure is described in clause 5.10.3.

Table 6: LBT threshold limits in line with ECC/DEC/(07)01 [i.4]

Band	Frequency range	Peak power threshold value (dBm/MHz)	Reaction time
1	Radar L-Band 1,215 GHz to 1,4 GHz	+8	Continuous listening of 12 s is required and automatic switch-off feasible each 10 ms if the threshold value is exceeded. In the case of detecting and switching off the transmitter, a silent time of at least 12 s while listening continuously is necessary.
2	MSS 1,61 GHz to 1,66 GHz	-43	Minimum continuous listening time of 40 ms before initial transmission of the device.
3	Land mobile service 2,5 GHz to 2,69 GHz	-50	Minimum continuous listening time of 40 ms before initial transmission of the device.
4	Radar S-Band 2,7 GHz to 3,4 GHz	-7	Continuous listening of 12 s is required and automatic switch-off feasible each 10 ms if the threshold value is exceeded. In the case of detecting and switching off the transmitter, a silent time of at least 12 s while listening continuously is necessary.

NOTE 1: If the RP in the respective band is lower than the limit as defined in the related standard, the threshold value can be increased by the difference.

NOTE 2: If the transmitter of the material sensor device is only active in one or more parts of the frequency range of the external service, the LBT receiver of the material sensor device has to be sensitive only in these parts. In this case the test signal frequency has to be adjusted accordingly.

Additional requirements for Radar detection (band 1 or band 4 of table 6): Continuously listening of 12 s and automatic switch-off within 10 ms for the related frequency range if the threshold value is exceeded (table 6). A silent time of at least 12 s while listening continuously is necessary before the transmitter can be switched on again.

### 5.10.3 Conformance

#### 5.10.3.1 Measurement Procedure

Within each LBT frequency range, the frequency and direction of the maximum mean power spectral density of the EUT within the scenario (indirect emission, see clause 5.7 and related standard) shall be recorded.

A test transmitter simulating the victim shall transmit a calibrated signal of the threshold level of clause 5.10.2 towards the EUT. The EUT shall be operated within the specified scenario (see related standard) in a continuous mode.

The transmitter simulating the victim shall be set to the recorded frequency and point to the EUT at the recorded direction of maximum mean power spectral density. The EUT is tested for the deactivation threshold to stop UWB emissions at the defined threshold levels as defined in clause 5.10.2.

#### 5.10.3.2 Test Set-Up

Figure 24 shows the test set-up for the LBT measurements for a generic EUT within a measurement scenario (indirect emissions see clause 5.7). The "Reference" point will be specified in the related standard (use-case and wanted technical performance criteria dependent). The details of the test scenario shall be specified in the related standard.

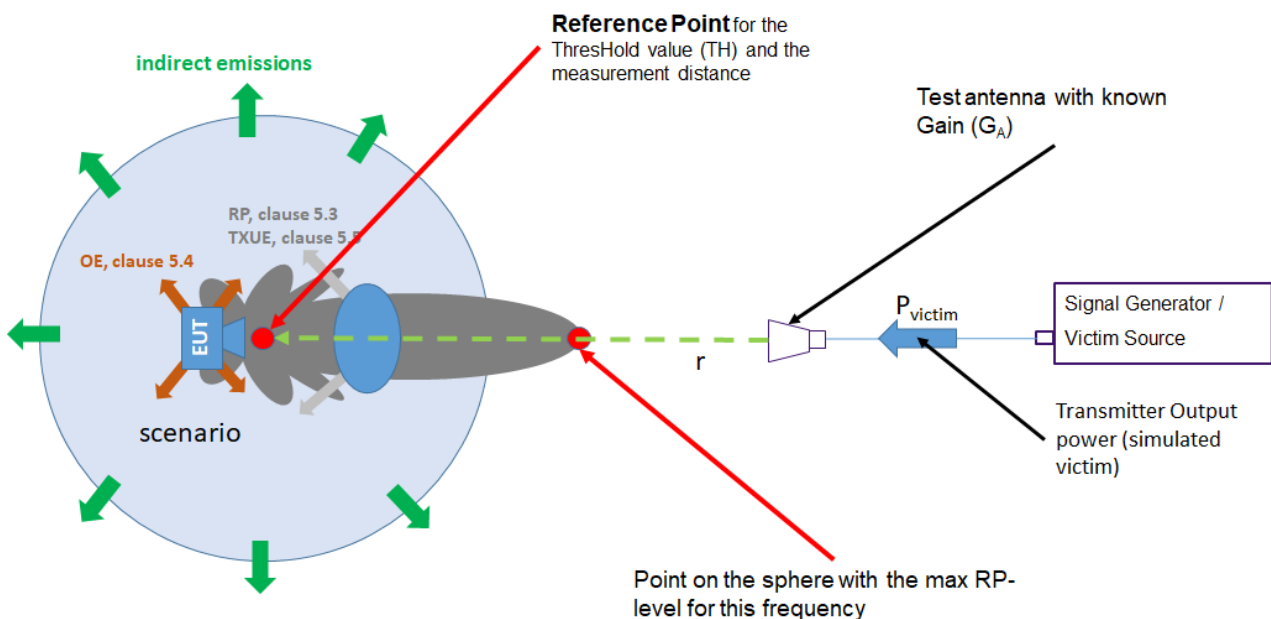

**Figure 24: Test set-up for LBT function**

Threshold power level at the reference point of the EUT (dBm/MHz), see (22):

$$th = p_{\text{victim}} + g_A - 20 \times \log \left( 4 \times r \times \pi \times \frac{f}{c_0} \right) \quad (22)$$

with (23) and (24):

$$g_A = 10 \times \log(G_{A(f)}) \quad (23)$$

$$p_{\text{victim}} = 10 \times \log(P_{\text{victim}}) \quad (24)$$

(25)

- $f$  is the carrier frequency of the victim source;

- $c_0$  the vacuum speed of light; and
- $r$  the distance between victim source test antenna and EUT reference point.

Thus, to reach the threshold power at the EUT, the power of the victim signal generator has to be set to the following power level (formula 25):

$$P_{\text{victim}} = \text{th} - g_A + 20 \times \log \left( 4 \times r \times \pi \times \frac{f}{c_0} \right) \quad (25)$$

### 5.10.3.3 Test Signal Definition for LBT Mechanism in Band 2 and 3

#### 5.10.3.3.1 Band 2: Mobile Satellite Service (MSS) Test Signal

For the Band 2: MSS test signal, see table 7.

- Victim signal power: see clause 5.10.3.2.

**Table 7: MSS test signal**

f (CW-Signal) [GHz]	See clause 5.10.3.1
Peak power threshold value at the EUT [dBm/MHz]	-43

#### 5.10.3.3.2 Band 3: Land Mobile Service Test Signal

For the Band 3: Land mobile service test signal, see table 8.

- Victim signal power: see clause 5.10.3.2.

**Table 8: Land mobile service test signal**

f (CW-Signal) [GHz]	See clause 5.10.3.1
Peak power threshold value at the EUT [dBm/MHz]	-50

### 5.10.3.4 Test Signal Definition for LBT Mechanism in Band 1 and 4

For radar services, the LBT mechanism has to be as quick as possible to avoid the second suppression of an echo of a target at the second rotation of the antenna dish (see figure 25). Normally, the air traffic control uses 3 consecutive echoes each received during the next consecutive rotation to validate "target" as "true" (the response of a transponder by a secondary radar is not taken into account here). Radar devices emits its PSD with a certain PRF, for example with a PRF of 1 100 Hz and a rotational speed of 0,25 Hz (1 rotation per 4 seconds). The radar main beam width is typically 1,5°, in this example the EUT beam width may be 20° (with a directivity/gain of 5 dB it is approximately 60°). Every 0,9 ms (= 1/PRF) the radar device emits 1 impulse. The criteria to switch off the sensor is to receive 5 times the main beam of the radar ( $5 \times 1/\text{PRF}$ ), in this example  $5 \times 1/1\ 100 = 4,5$  ms. That means after detection of the 5 radar impulses plus a reaction time, the EUT switches off (display might show a "hit", e.g. "interference signal"). Now a latency time of 12 seconds has to be introduced during which the EUT only receives (no transmission, i.e. to cover the window for the slowest rotation rate of radar device). If during this 12 s the main beam is detected again, the display hint will continue. If not, the measurement procedure can start again, because the interferer does not belong to a radar service.

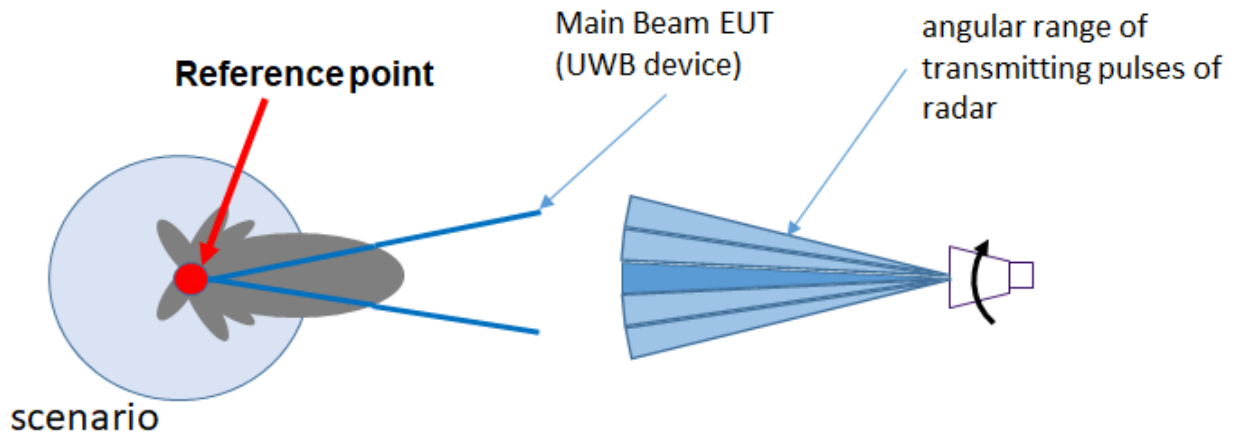

**Figure 25: LBT - radar scenario for Bands 1 and 4**

If such a radar signal (pulse train of 5 pulses, see figure 26) is detected, then the EUT transmitter shall be switched off within max. 10 ms. After detecting of the radar signal a waiting time of > 12 seconds shall be implemented in which the EUT is only receiving. If a next radar signal is detected the timer (12 seconds) shall be triggered again.

Based on the timing of the radar active in the two bands following test signals (with 5 pulses) shall be implemented within a signal generator to simulate a possible "radar signal" at the UWB device (see figure 26).

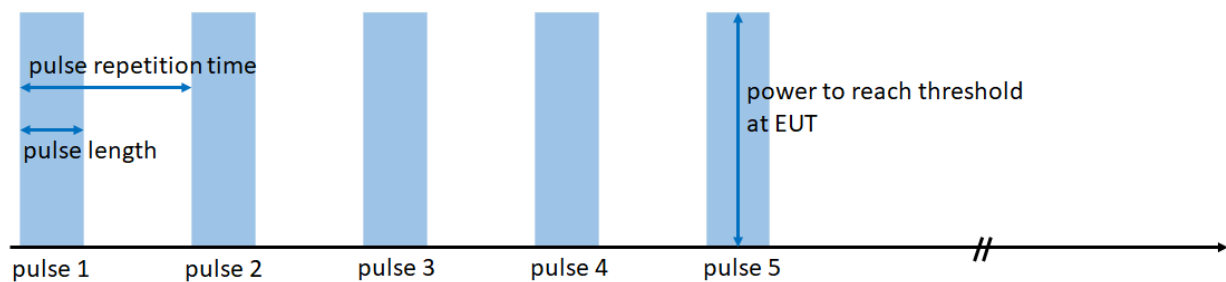

**Figure 26: LBT - radar scenario, test pattern**

**Test pattern 1:**

**Table 9: Test pattern 1**

Pulse length	0,4 $\mu$ s
Pulse repetition time	0,8 ms

**Test pattern 2:**

**Table 10: Test pattern 2**

Pulse length	90 $\mu$ s
Pulse repetition time	1,5 ms

**Radar Test signals:**

For the band 1 and band 4 test signals see table 11.

- Pulse power: see clause 5.10.3.2.

Table 11: Radar test signals

	L-Band	S-Band
Test pattern	1 (table 9) and 2 (table 10)	1 (table 9) and 2 (table 10)
f [GHz]	See clause 5.10.3.1	See clause 5.10.3.1
Peak power threshold at the EUT [dBm/MHz]	8	-7

### 5.10.3.5 Conformance Test to Measure the Timing for LBT within bands 1 and 4

For the LBT mechanism within Radar bands 1 and 4, the following timings need to be measured:

- EUT switch off time < 10 ms after radar signal detection
- Silent time of 12 s of the EUT after radar signal detection

The measurement procedure and test setup follow clauses 5.10.3.1 and 5.10.3.2 with the following modifications: In addition to the victim source pointing at the EUT, the EUT emissions need to be measured with a test antenna. The setup is shown in figure 27.

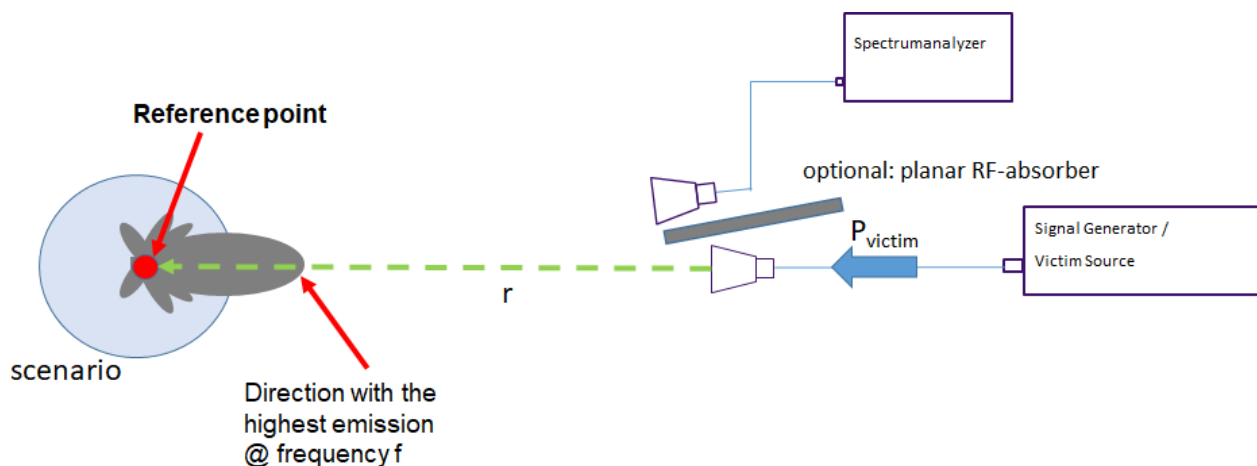

Figure 27: Test-set-up to assess the LBT timing for band 1 and band 4

The planar RF-absorber is optional to reduce the cross talk between victim test antenna and measurement antenna. If such planar RF-absorber will be used, the victim threshold power level at the EUT shall be checked again, see clause 5.10.3.2.

Both the victim source antenna and the antenna measuring the EUT emissions shall point to the EUT in the recorded direction of maximum mean power spectral density within the LBT frequency bands 1 or 4 according to clauses 5.10.3.1 and 5.10.3.2 (see figure 24).

A spectrum analyser is used to measure the EUT emissions. Because of reflections and cross talk between the victim source antenna and the antenna measuring the EUT emissions, also the victim signal is measured by the spectrum analyser in addition to the EUT emissions.

The victim source test signal is set as defined in clause 5.10.3.4.

The following spectrum analyser settings shall be applied:

- Zero span mode/time domain mode
- Frequency: Frequency of maximum mean power spectral density of the EUT (clause 5.10.3.1)
- Resolution bandwidth: 1 MHz
- Detector: RMS

Both EUT emissions and victim source signal need to be simultaneously seen at the spectrum analyser and need to be distinguishable.

If the dynamic range of the spectrum analyser does not allow to observe both EUT emissions and victim source signal with the same settings, the victim source signal might be offset in frequency to adapt the received power in the resolution bandwidth of the spectrum analyser.

The two timings specified above shall be measured with the spectrum analyser.

Figure 28 shows an example of the measured Spectrum Analyser signals for of the EUT switch off.

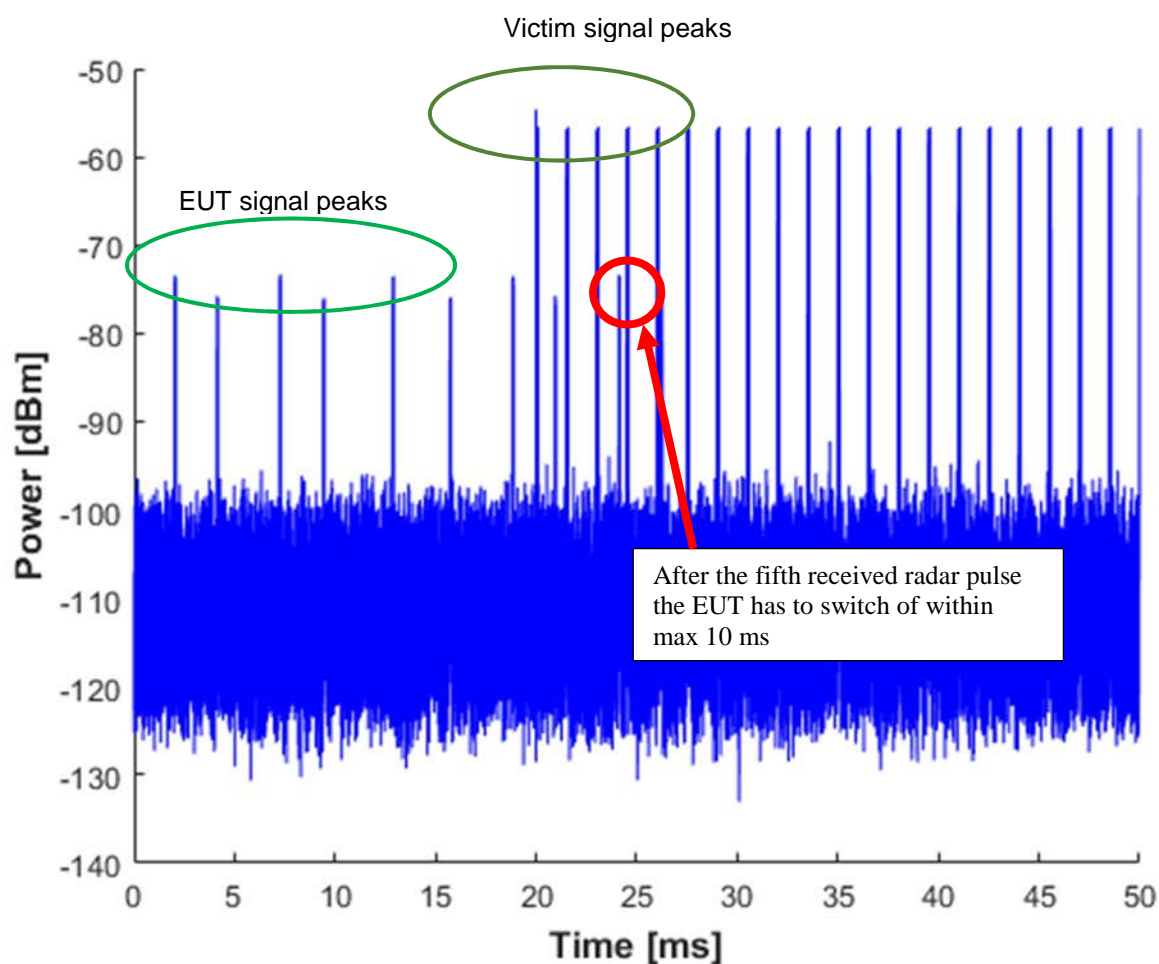

Figure 28: Example signals for the LBT timing measurements

## 5.11 Duty Cycle

### 5.11.1 Description

Duty Cycle (DC) is a passive mitigation technique often used in radio regulation and harmonised standards in order to enable spectrum sharing between different radio devices and/or radio applications. A duty cycle regulation is normally stated as a limitation to activity of a transmitter within certain time and power boundaries, e.g. allowing a defined percentage of transmission activity at some predefined levels of transmitted power during the  $T_{on}$  (see ETSI TR 103 181-2 [i.14]).

## 5.11.2 Conformance

### 5.11.2.1 Duty Cycle, Spectrum Analyser Method

The method in this clause is intended for duty cycle requirements over short observation periods, as specified in the relevant standard (usually over 1 second). Conformance for duty cycle requirements over long-term periods (usually over 1 hour) is addressed in clause 5.11.2.4.

The method is based on ETSI TS 103 060 [i.1].

When measuring the EUT duty cycle, the spectrum analyser or equivalent shall be configured as follows unless otherwise stated in the relevant harmonised standard:

- Resolution Bandwidth: As specified in the related harmonised standard
- Video Bandwidth: Not less than the resolution bandwidth
- Display Mode: Max hold
- Frequency Span: Zero span
- Centre Frequency: The frequency of the maximum mean power spectral density as recorded under clause 5.3.2.2

To optimize the signal-to-noise ratio, it is recommended that radiated measurements are taken in the direction of the maximum level of the mean power spectral density.

The duty cycle timings may vary because of different coding schemes. The first sweep(s) should be an overview of the duty cycle timings. The manufacturer should also declare these timings.

For further evaluation, choose an observation period with maximum "on" time,  $T_{on}$ , and minimum "off" time,  $T_{off}$ , taking into account the disregard time,  $T_{dis}$ .

Calculate the  $T_{on}$  and  $T_{off}$  times taking into account the  $T_{dis}$  and  $P_{thresh}$  as defined in ETSI TS 103 060 [i.1] and as specified in the relevant standard. From these, the duty cycle is calculated as (26):

$$\text{Duty Cycle} = \frac{\sum T_{on}}{T_{obs}} = \frac{\sum T_{on}}{\sum T_{on} + \sum T_{off}} \quad (26)$$

The related standard shall specify:  $T_{obs}$ ,  $T_{dis}$  and  $P_{thresh}$ .

The oscilloscope method in clause 5.11.2.2 can be used as an alternative.

### 5.11.2.2 Duty Cycle, Oscilloscope Method

The method in this clause is intended for duty cycle requirements over short observation periods, as defined in the relevant harmonised standard (usually over 1 second). Conformance for duty cycle requirements over long-term periods is addressed in clause 5.11.2.4.

The method is based on ETSI TS 103 060 [i.1].

Unless otherwise stated in the harmonised standard, the spectrum analyser method in clause 5.11.2.1 is equivalent and may be used as an alternative.

The following tools shall be used to execute the time domain procedure for DC measurement:

- One 50  $\Omega$  cable in case of conducted testing.
- One Oscilloscope with the following minimum requirements:
  - Sampling frequency  $> 2 B$  (where  $B$  is the pulse bandwidth): this requirement is enough to detect the envelope of the signal and ensure the correct operation of the measurement procedure.



- Input bandwidth  $> f_H$  (where  $f_H$  is the highest frequency, i.e. the upper boundary to the operating frequency range).
- One Personal Computer with installed a Post Processing Tool.

### Conducted emission

Figure 29 illustrates the general test setup to execute the time domain procedure for DC measurement in the case of conducted emission.

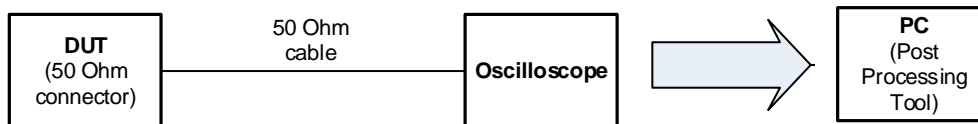

**Figure 29: General test setup to execute the time domain procedure for DC measurement in the case of conducted emission**

### Radiated emission

Figure 30 illustrates the general test setup to execute the time domain procedure for DC measurement in the case of radiated emission. To optimize the signal-to-noise ratio, it is recommended that radiated measurements are taken in the direction of the maximum level of the mean power spectral density.

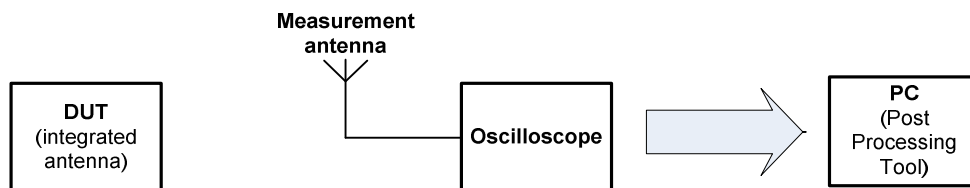

**Figure 30: General test setup to execute the time domain procedure for DC measurement in the case of radiated emission**

For EUT which implement DC mitigation, the manufacturer shall be provide information about the different possible DC timings (within the different modes).

Configure the oscilloscope as follows:

- Set the signal sampling frequency  $f_c$  of the oscilloscope such that  $f_c \geq 2(f_H f_L)$ , where  $f_H$  and  $f_L$  are the boundaries to the operating frequency range from clause 5.2.
- Adjust the time division such that the entire observation period fits within the memory storage capability of the oscilloscope. Verify that the sampling period of the scope is smaller than or equal to  $T_{dis}/2$ .
- Adjust the vertical scale of the oscilloscope to the lowest value that still displays the entire dynamic range of the signal.

The duty cycle timings may vary because of different coding schemes. The first sweep(s) should be an overview of the duty cycle timings. The manufacturer should also declare these timings.

For further evaluation, choose an observation period with maximum "on" time,  $T_{on}$ , and minimum "off" time,  $T_{off}$ , taking into account the disregard time,  $T_{dis}$ .

Calculate the  $T_{on}$  and  $T_{off}$  times taking into account the  $T_{dis}$  and  $P_{thresh}$  specified in the related standard and ETSI TS 103 060 [i.1]. From these, the duty cycle is calculated as (27):

$$\text{Duty Cycle} = \frac{\sum T_{on}}{T_{obs}} = \frac{\sum T_{on}}{\sum T_{on} + \sum T_{off}} \quad (27)$$

The related standard shall specify:  $T_{\text{obs}}$ ,  $T_{\text{dis}}$  and  $P_{\text{thresh}}$ .

### 5.11.2.3 Duty Cycle Measurement Methods for FMCW, stepped-frequency and Pulsed Systems

#### 5.11.2.3.1 General

The methods in this clause are intended for duty cycle requirements for FMCW, stepped-frequency and pulsed systems. Observation periods are defined in the relevant harmonised standard. These periods are typically in the range of 0,1 to 10 s. But these methods cover also other periods.

There are three methods described which all can be used depending on the system parameters and the available measurement equipment. The measurement results will be the same within the measurement uncertainty for each measurement method if applied as described below:

- The first method (see clause 5.11.2.3.2) uses a diode power detector and can be used for pulsed, stepped-frequency and FMCW systems.
- The second method (see clause 5.11.2.3.3) uses a spectrum analyser in zero span mode. This can also be used for pulsed and FMCW systems.
- The last method (see clause 5.11.2.3.4) uses a spectrum analyser synchronized with another one and is only suited for FMCW and stepped-frequency systems.

The methods can be used also if there are more than one pulse train or more than one FMCW or stepped-frequency sweep within the signal repetition time, as long as the bandwidth of each pulse train/FMCW or stepped-frequency sweep is the same. If the bandwidth differs within the signal repetition time, the pulse trains/FMCW or stepped-frequency sweeps have to be measured separately.

If the EUT has an integrated RF antenna a further RX test antenna is needed for the measurement setup. This can be a standard gain horn antenna suited for the frequency range to be measured. If the EUT is equipped with a 50 Ohm connector or a wave guide connector it can be connected directly to the measurement device.

If not otherwise specified in the related standard: For measurements with the spectrum analyser the threshold level  $P_{\text{Thresh}}$  as defined in ETSI TS 103 060 [i.1] shall be set to 10 dB below the max emission limit (see clause 5.3).

#### 5.11.2.3.2 Method 1: Diode Power Detector

This method can be used for pulse, stepped-frequency and FMCW signals. The measured  $T_{\text{on}}$  on the Oscilloscope represents the burst duration of the FMCW burst in FMCW systems, the emission duration in stepped-frequency systems, or the duration of the pulse train in pulsed systems respectively.

Measurement device:

- RF power detector based on detector diodes (thermal detectors are not appropriate as these are usually too slow), covering a frequency range which at least include the OFR of the EUT
- Oscilloscope

When measuring the EUT duty cycle, the measurement equipment shall be configured as follows unless otherwise stated in the relevant harmonised standard:

- Connect the RX test antenna to the RF power detector. Adjust the position of the RX test antenna and the antenna of the EUT to have maximum RF coupling
- Alternatively, if possible, connect the EUT directly to the RF power detector by cable or wave guide
- Connect the oscilloscope to the output of the RF power detector
- Switch on the EUT
- Adjust the oscilloscope settings (time base, voltage range, trigger) to see the detected pulse from the power detector

- Measure  $T_{on}$ . If there is more than one pulse within the signal repetition time (see annex C) measure  $T_{on}$  for every single pulse
- Measure the signal repetition time  $T_{rep}$ , see annex C
- Calculate the Duty Cycle with (28):

$$\text{Duty Cycle}[\%] = \frac{\sum T_{on}}{T_{rep}} * 100 \quad (28)$$

### 5.11.2.3.3 Method 2: Spectrum Analyzer

#### 5.11.2.3.3.1 General

This method can be used for pulsed systems and FMCW systems.

Method 2a: is for pulsed systems and for FMCW where the operating frequency range is smaller than the resolution bandwidth of the spectrum analyser, see clause 5.11.2.3.3.2.

Method 2b: is for FMCW where the operating frequency range is equal to or larger than the resolution bandwidth of the spectrum analyser, see clause 5.11.2.3.3.3.

#### 5.11.2.3.3.2 Method 2a

Measurement device:

- Spectrum analyser in zero span mode on centre frequency of the OFR

When measuring the EUT duty cycle, the measurement equipment shall be configured as follows unless otherwise stated in the relevant harmonised standard:

- Connect the RX test antenna to the spectrum analyser. Adjust the position of the RX test antenna and the antenna of the EUT to have maximum RF coupling
- Alternatively, if possible, connect the EUT directly to the spectrum analyser
- Set spectrum analyser frequency to the centre frequency of the OFR
- Set spectrum analyser to zero span mode
- Set spectrum analyser resolution bandwidth as large as possible, up to a maximum of 50 MHz
- Set spectrum analyser detector mode to peak
- Switch on the EUT
- Adjust the spectrum analyser settings (sweep time, amplitude range, trigger on RF power) to see the complete signal repetition time  $T_{rep}$  in zero span mode, see annex C
- Measure the signal repetition time  $T_{rep}$ , see annex C
- Set the sweep time of the spectrum analyser to show one pulse in one sweep with high resolution
- Measure the pulse length  $T_{on}$ . This is the time between the points where rising and falling edge are crossing the threshold level of X dB the maximum level. The value for X is given in the related standard. If no value for X is provided in the related standard, then the value of 3 dB shall be used. This 3 dB correspond to the RBW definition of the spectrum analyser. If there is more than one pulse within the signal repetition time (see annex C,) measure  $T_{on}$  for every pulse:

$$\text{Duty Cycle}[\%] = \frac{\sum T_{on}}{T_{rep}} * 100 \quad (29)$$

### 5.11.2.3.3 Method 2b

This method can be used for FMCW systems where the operating frequency range is larger than the resolution bandwidth of the spectrum analyser (30) until (32):

- Measure the peak e.i.r.p. spectral density power  $P_{pk}$  [dBm] of the FMCW signal according to clause 5.3.4.3
- Measure the mean e.i.r.p. spectral density  $P_{av}$  [dBm] of the FMCW signal according to clause 5.3.2.5
- The difference between mean e.i.r.p. power spectral density and peak e.i.r.p. power spectral density is the sum of the duty cycle and the relation of the RBW of the spectrum analyser and the modulation bandwidth of the FMCW signal which is equal to the OFR according to clause 5.2

Bandwidth relation in dB ( $B_{wrel}$ ):

$$B_{wrel} \text{ [dB]} = 10 \times \log\left(\frac{OFR \text{ [MHz]}}{1 \text{ [MHz]}}\right) \quad (30)$$

Duty cycle in dB:

$$DC \text{ [dB]} = P_{av} \text{ [dBm]} + B_{wrel} \text{ [dB]} - P_{pk} \text{ [dBm]} \quad (31)$$

Duty cycle in %:

$$DC \text{ [%]} = 100 \times 10^{\frac{DC \text{ [dB]}}{10}} \quad (32)$$

### 5.11.2.3.4 Method 3: Synchronized Spectrum Analysers

This method is only appropriate for FMCW and stepped-frequency systems. Two spectrum analysers are used. The first one is used to detect the start of the FMCW or stepped-frequency sweep and to generate a trigger signal for the second spectrum analyser. The second one is used to measure the timing  $T_{on}$  and  $T_{rep}$ . Both spectrum analysers have to be connected to an RX test antenna or, if possible, direct to the EUT via a power splitter and cable or wave guide.

Measurement device:

- Two spectrum analysers in zero span mode

When measuring the EUT duty cycle from the radio device, the measurement equipment shall be configured as follows unless otherwise stated in the relevant harmonised standard:

- Connect one RX test antennas to each of both spectrum analysers. Adjust the positions of the RX test antennas and the antenna of the EUT to have maximum RF coupling for both test antennas
- If the EUT provide a coaxial connector or a wave guide connector connect the EUT directly to both spectrum analysers via a power splitter and cable or wave guide
- Set spectrum analyser 1 resolution bandwidth to as large as possible
- Set spectrum analyser 1 detector mode to peak
- Set spectrum analyser 1 to zero span mode
- Set spectrum analyser 1 frequency to  $f_L$
- Set spectrum analyser 2 resolution bandwidth to 1 MHz
- Set spectrum analyser 2 detector mode to peak
- Set spectrum analyser 2 to zero span mode
- Set spectrum analyser 2 frequency to  $f_L$
- Switch on the EUT

- Adjust the spectrum analyser 1 settings (time span, amplitude setting range, trigger on RF power) to see the detected pulse in zero span mode
- Connect the trigger output or video output of the spectrum analyser 1 to the external trigger input of spectrum analyser 2
- Adjust the spectrum analyser 2 settings (time span, amplitude setting range, trigger on external) to see the detected pulse in zero span mode
- Measure the absolute time  $t_1$  at the rising edge of the pulse related to the trigger signal. (can be positive or negative but should be close to zero)
- Set spectrum analyser 2 frequency to  $f_H$
- Measure the absolute time  $t_2$  at the falling edge of the pulse related to the trigger signal

$$T_{ON} = t_2 - t_1 \quad (33)$$

- If there are more than one FMCW sweep within the signal repetition time, there will be more than 1 pulse on frequency  $f_L$  and  $f_H$ .  $T_{on}$  for every sweep has to be measured separately.  $T_{on}$  for every sweep start with rising edge of the pulse on  $f_L$  and ends with the first following pulse on  $f_H$
- Enlarge the time span to see the complete signal repetition time  $T_{rep}$ . Measure the signal repetition time  $T_{rep}$

$$\text{Duty Cycle}[\%] = \frac{\sum T_{on}}{T_{rep}} \times 100 \quad (34)$$

#### 5.11.2.4 Duty Cycle Measurement Methods within a frequency band for FMCW and stepped-frequency systems

##### 5.11.2.4.1 General

The method in this clause is intended for duty cycle requirements within a frequency band for FMCW and stepped-frequency systems. The requirement to limit the duty cycle in certain sub-frequency bands within the permitted range of operation is defined in the relevant harmonised standard, as well as the observation periods. These observation periods are typically in the range of 0,1 to 10 s. But the method covers also other periods.

The measurement method (see clause 5.11.2.4.2) uses a spectrum analyser synchronized with another one and is only suited for FMCW and stepped-frequency systems.

The method can be used also if there is more than one FMCW or stepped-frequency sweep within the signal repetition time, as long as the bandwidth of each sweep is the same. If the bandwidth differs within the signal repetition time, the sweeps have to be measured separately.

If the EUT has an integrated RF antenna a further RX test antenna is needed for the measurement setup. This can be a standard gain horn antenna suited for the frequency range to be measured. If the EUT is equipped with a 50 Ohm connector or a wave guide connector it can be connected directly to the measurement device.

If not otherwise specified in the related standard: For measurements with the spectrum analyser the threshold level  $P_{Thresh}$  as defined in ETSI TS 103 060 [i.1] shall be set to 10 dB below the max emission limit (see clause 5.3).

##### 5.11.2.4.2 Synchronized Spectrum Analysers

This method is appropriate for FMCW and stepped-frequency systems. Two spectrum analysers are used. The first one is used to detect the start of the FMCW or stepped-frequency sweep within the sub-frequency band and to generate a trigger signal for the second spectrum analyser. The second one is used to measure the timing  $T_{on}$  and  $T_{rep}$ . Both spectrum analysers have to be connected to an RX test antenna or, if possible, direct to the EUT via a power splitter and cable or wave guide.

Measurement device:

- Two spectrum analysers in zero span mode

When measuring the EUT duty cycle from the radio device, the measurement equipment shall be configured as follows unless otherwise stated in the relevant harmonised standard:

- Connect one RX test antennas to each of both spectrum analysers. Adjust the positions of the RX test antennas and the antenna of the EUT to have maximum RF coupling for both test antennas
- If the EUT provide a coaxial connector or a wave guide connector connect the EUT directly to both spectrum analysers via a power splitter and cable or wave guide
- Set spectrum analyser 1 resolution bandwidth to as large as possible
- Set spectrum analyser 1 detector mode to peak
- Set spectrum analyser 1 to zero span mode
- Set spectrum analyser 1 frequency to the lowest emission frequency within the sub-frequency band
- Set spectrum analyser 2 resolution bandwidth to 1 MHz
- Set spectrum analyser 2 detector mode to peak
- Set spectrum analyser 2 to zero span mode
- Set spectrum analyser 2 frequency to the lowest emission frequency within the sub-frequency band
- Switch on the EUT
- Adjust the spectrum analyser 1 settings (time span, amplitude setting range, trigger on RF power) to see the detected pulse in zero span mode
- Connect the trigger output or video output of the spectrum analyser 1 to the external trigger input of spectrum analyser 2
- Adjust the spectrum analyser 2 settings (time span, amplitude setting range, trigger on external) to see the detected pulse in zero span mode
- Measure the absolute time  $t_1$  at the rising edge of the pulse related to the trigger signal. (can be positive or negative but should be close to zero)
- Set spectrum analyser 2 frequency to the highest emission frequency within the sub-frequency band
- Measure the absolute time  $t_2$  at the falling edge of the pulse related to the trigger signal:

$$T_{ON} = t_2 - t_1 \quad (35)$$

- If there is more than one sweep within the signal repetition time, there will be more than 1 pulse on the lowest and highest emission frequency within the sub-frequency band.  $T_{on}$  for every sweep has to be measured separately.  $T_{on}$  for every sweep start with rising edge of the pulse on the lowest emission frequency within the sub-frequency band and ends with the first following pulse on the highest emission frequency within the sub-frequency band
- Enlarge the time span to see the complete signal repetition time  $T_{rep}$ . Measure the signal repetition time  $T_{rep}$ :

$$\text{Duty Cycle}[\%] = \frac{\sum T_{on}}{T_{rep}} \times 100 \quad (36)$$

The observation period of the individual measurement can be reduced if max hold is used during at least the specified observation time. The max hold function has the effect to capture the max.  $T_{on}$  and the min.  $T_{rep}$  and thus leads to the worst case duty cycle.

Remark: If the frequency sweeps are not increasing in frequency, the temporally first and last emission frequency within the sub-frequency band have to be set to measure  $t_1$  and  $t_2$ .

Example measurement for a stepped-frequency system, (see figure 31) evaluated the Duty Cycle requirement for a material sensing device, covered by the ECC/DEC/(07)01 [i.4] in the 3,4 - 3,8 GHz frequency band.

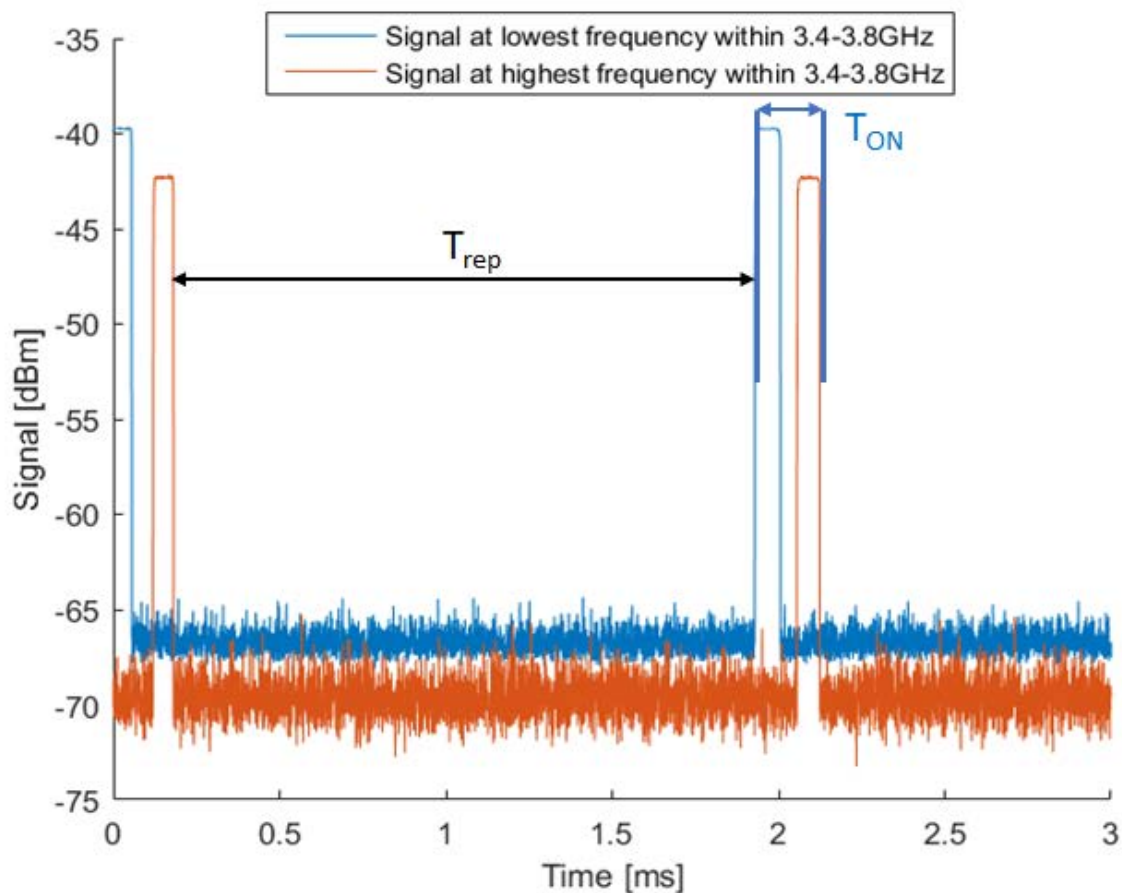

**Figure 31: Example measurement for a stepped-frequency system, evaluated in the 3,4 - 3,8 GHz frequency band**

The assessment of the measurement in figure 31 provide following results:

NOTE: The max hold was used for at least 1 s.

- $T_{rep}$ : 1,94 ms
- $T_{on}$  within the range 3,4 to 3,8 GHz: 0,18 ms

Result: with formula (36) this would lead to a DC within 3,4 to 3,8 GHz of: 9,3 %.

---

# Annex A (normative): General Considerations and test conditions

## A.1 Overview

In this annex all general considerations for the testing of UWB devices will be given. These considerations and requirements are related to:

- Product Information (see clause A.2)
- Test Modulation (see clause A.3)
- Guidance on EUT Modulation for Testing (see clause A.4)
- Test Conditions (see clause A.5)
- Choice of Equipment for Test Suites (see clause A.6)
- Testing of Host Connected Equipment and Plug-In Radio Devices (see clause A.7)
- Interpretation of the measurement results (see clause A.8)
- Specific Test Setup and Test Scenarios, see related standard

---

## A.2 Product Information

The following product information from the technical documentation file is necessary to perform the test:

- The environmental profile as declared by the manufacturer and user/installation information (conformity documentation, annex V of the RED [i.32]), see related standard.
- The type of (UWB) technology implemented in the equipment (e.g. carrier-based, impulse, etc.).
- If known the signal repetition time of the used (UWB) modulations.
- The type of modulation schemes available (e.g. OFDM modulation, pulsed modulation like PPM or Pulse Polarity Modulation or any other type of modulation, etc.).
- For all modulation schemes the modulation parameters need to be provided.
- The intended operating frequency range(s) of the equipment.
- If known the duty cycle or the duty cycle range of the EUT.
- The type of the equipment (e.g. stand-alone equipment, plug-in radio device, combined equipment, etc.), and if required the necessary companion devices.
- The intended combination(s) of the radio equipment power settings and one or more antenna assemblies and their corresponding e.i.r.p. levels.
- The nominal power supply voltages of the stand-alone radio equipment or the nominal power supply voltages of the host equipment or combined equipment in case of plug-in radio devices.
- The inclusion and any necessary implementation details of features such as gating or hopping.
- The inclusion and any necessary implementation details of any mitigation or equivalent mitigation techniques.
- In case of conducted measurements, the antenna port characteristics as well as maximum antenna gain characteristics (frequency response) over the relevant frequency range covered in the related standard.



- The manufacturer shall provide the means to operate and monitor the EUT during the tests.

---

## A.3 Guidance on EUT Modulation for Testing

The EUT modulation used should be representative of normal use of the equipment and which results in the highest RP which would be available in normal operation. The manufacturer provides the information of the modulations utilized within the technical documentation file of the EUT.

The highest mean transmit power spectral density is also likely to be affected by frame/packet length, inter-packet gaps, normal and burst modes. The manufacturer shall provide this information and the settings that were used which are considered to lead to the highest mean transmit power spectral density available in normal operation.

Implemented transmitter timeout functionality should be disabled for the sequence of the test suite.

Where radio devices are equipped with LDC mitigation, the LDC operation may be disabled for the duration of the RP test.

---

## A.4 Requirements in Case of EUT with Scanning Antennas

### A.4.1 Classification

For the purposes of the present document, EUTs are divided into three types according to the behaviour in time of the transmit antenna:

- **Fixed beam.** In this type of EUT the antenna radiation pattern is constant, and the boresight direction is fixed relative to the housing of the EUT.
- **Constant pattern.** In this type of EUT the radiation pattern of the antenna is constant, and the boresight direction varies with time. The scanning of the boresight direction is at a constant angular rate of change.
- **Variable pattern.** This type of EUT is all those that are not fixed or constant pattern. Either the antenna radiation pattern varies with time and/or direction or the scanning is not at a constant rate.

For the purposes of the above classification, fixed and constant mean within 1° or 1 % as appropriate in normal operation.

NOTE 1: The classification depends only on the transmit antenna behaviour.

NOTE 2: In general, mechanically scanned antennas will be constant pattern and electronically scanned antennas will be variable pattern.

NOTE 3: Although the terms beam and pattern are used in the singular the same considerations and classifications apply to EUT with multiple beams.

### A.4.2 Measurement of Fixed Beam EUT

No special considerations apply. Measurements shall be made on the boresight unless otherwise specified.

### A.4.3 Measurement of Constant Pattern EUT

The scanning may be inhibited, and measurements made on the boresight unless otherwise specified. The parameters of the EUT in normal operation may be calculated based on knowledge of the antenna behaviour. The manufacturer shall declare the relevant antenna parameters.

## A.4.4 Measurement of Variable Pattern EUT

Measurements shall be made with the antenna scanning. It may be necessary to perform a set of measurements over the full sphere or half sphere. For measurements of radiated energy (e.g. peak power, mean power, duty cycle) the direction shall be chosen which gives the highest value result.

---

## A.5 Test Conditions, Power Supply and Ambient Temperatures

### A.5.1 General

The equipment has to comply with all the technical requirements as identified in annex A of the related harmonised standards at all times when operating within the boundary limits of the declared operational environmental profile.

However, practical measurements are usually not realistic to be done at each and every possible combination of the environmental profile due to the huge time required; For example the environmental profile of an indoor use in a residential environment with a temperature range 15 - 35° and a relative humidity range 20 - 70 % would require around 1 000 measurements (of all parameters) when considering each combination with a step size of 1° temperature and 1 % humidity. Assuming half a day to measure all conformance requirements at one environmental points, then the measurement would take 250 days!

The key is here to carry out tests under a sufficient variety of environmental conditions (within the boundary limits of the declared operational environmental profile) to give confidence of compliance for the affected technical requirements under the complete environmental profile. The following procedure would be reasonable to achieve the compliance for the affected technical requirements over the declared operational environmental profile of the equipment:

- The manufacturer should declare the environmental profile of the equipment.
- Representative points within the boundary limits of the declared operational environmental profile should be selected for the measurements (e.g. lowest and highest values) ; it should be noted that dependent on the size of the EUT the test might only be possible at the environmental condition at the test site.
- The manufacturer could provide in the technical documentation file (see article 21 of Directive 2014/53/EU [i.32]) other information which shows that the equipment is expected to fulfil the conformance requirements over the complete environmental profile, e.g. simulation results, measurements at the board, data sheets.

### A.5.2 Power Sources

#### A.5.2.1 Power Sources for Stand-Alone Equipment

During testing, the power source of the equipment may be replaced by a test power source capable of producing normal test voltages as specified in clause A.5.3.1.2. The internal impedance of the test power source shall be low enough for its effect on the test results to be negligible. For the purpose of tests, the voltage of the power source shall be measured at the input terminals of the equipment.

Battery operated equipment may be tested with the standard internal battery, or the battery may be removed and replaced with a test power source.

If a test power source is used, it shall be applied as close to the battery terminals as possible. During tests, its voltages shall be maintained within a tolerance of  $\pm 1$  % relative to the voltage at the beginning of each test. The value of this tolerance is critical to power measurements; using a smaller tolerance will provide better measurement uncertainty values.

## A.5.2.2 Power sources for plug-in radio devices

The power source for testing plug-in radio devices shall be provided by test fixture or host equipment.

Where the host equipment and/or the plug-in radio device is battery powered, the battery may be removed, and the test power source applied as close to the battery terminals as practicable.

## A.5.3 Normal and Extreme Test Conditions

### A.5.3.1 Normal Test Conditions

#### A.5.3.1.1 Normal Temperature and Humidity

The normal temperature and humidity conditions for tests shall be any convenient combination of temperature and humidity within the following ranges:

- temperature: +15 °C to +35 °C;
- relative humidity: 20 % to 75 %.

When it is impracticable to carry out the tests under these conditions, a note to this effect, stating the ambient temperature and relative humidity during the tests, shall be recorded.

The actual values during the tests shall be recorded.

#### A.5.3.1.2 Normal Power Source

##### A.5.3.1.2.1 Mains Voltage

The normal test voltage for equipment to be connected to the mains shall be the nominal mains voltage. For the purpose of the present document, the nominal voltage shall be the voltage(s) for which the equipment was designed.

The frequency of the test power source corresponding to the AC mains shall be between 49 Hz and 51 Hz.

##### A.5.3.1.2.2 Lead-Acid Battery Power Sources used on Vehicles

When radio equipment is intended for operation from the usual, alternator fed lead-acid battery power source used on vehicles, then the normal test voltage shall be 1,1 times the nominal voltage of the battery (6 V, 12 V, etc.).

##### A.5.3.1.2.3 Other Power Sources

For operation from other power sources or types of battery (primary or secondary), the nominal test voltage shall be as stated by the equipment manufacturer. This shall be recorded.

### A.5.3.2 Extreme Conditions

#### A.5.3.2.1 Extreme Temperatures

##### A.5.3.2.1.1 Procedure for Tests at Extreme Temperatures

Before measurements are made, the equipment shall have reached thermal balance in the test chamber.

Before tests at the upper temperatures of the environmental profile the equipment shall be placed in the test chamber and left until thermal balance is attained. The equipment shall then be switched on in the transmit condition for a period of a half hour after which the equipment shall meet the specified requirements.

For tests at the lower temperatures of the environmental profile, the equipment shall be left in the test chamber until thermal balance is attained, then switched on for a period of one minute after which the equipment shall meet the specified requirements.

If the thermal balance is not checked by measurements, a temperature stabilizing period of at least one hour, or such period as may be decided by the accredited test laboratory, shall be allowed. The sequence of measurements shall be chosen, and the humidity content in the test chamber shall be controlled so that excessive condensation does not occur.

#### A.5.3.2.1.2 Extreme Temperature Ranges

For tests at extreme temperatures, measurements shall be made in accordance with the procedures specified in the related HS, at the upper and lower temperatures of the environmental profile of the EUT.

The test report shall state which temperatures are used.

#### A.5.3.2.2 Extreme Test Source Voltages

##### A.5.3.2.2.1 Mains Voltage

The extreme test voltages for equipment to be connected to an AC main source shall be the nominal mains voltage  $\pm 10\%$ .

##### A.5.3.2.2.2 Other Power Sources

For equipment using other power sources, or capable of being operated from a variety of power sources, the extreme test voltages shall be those that are specified in the technical documentation file. These shall be recorded in the test report.

#### A.5.3.2.3 Radio Transparent Temperature Chamber

A temperature chamber fitted with a radio transparent door or wall may be used to perform radiated measurements. The procedure would in this case be the same as the one specified under normal conditions.

The EUT shall be placed onto a radio transparent support. The distance between the test antenna and the EUT shall be in accordance with the related standard. Figure A.1 shows a possible test set-up.

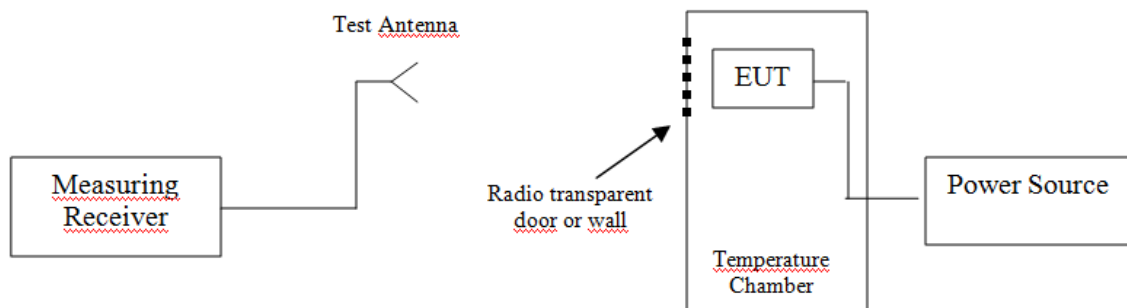

**Figure A.1: Extreme conditions set-up**

#### A.5.3.2.4 Use of a Test Fixture

##### A.5.3.2.4.1 General

Alternatively, a test fixture may be used to facilitate measurements under extreme conditions.

### A.5.3.2.4.2 Characteristics

The fixture is a radio frequency device for coupling the integral antenna of the EUT to a 50  $\Omega$  RF terminal at all frequencies for which measurements need to be performed.

The test fixture shall be fully described, see figure A.2.

In addition, the test fixture shall provide:

- a) a connection to an external power supply;
- b) a method to provide the input to or output from the equipment. This may include coupling to or from the antenna. The test fixture could also provide the suitable coupling means e.g. for data or video outputs.

The test fixture is normally be supplied by the manufacturer.

The performance characteristics of the test fixture shall be approved by the testing laboratory and shall conform to the following basic parameters:

- a) the coupling loss shall not be greater than 30 dB;
- b) adequate bandwidth properties;
- c) a coupling loss variation over the frequency range used for the measurement shall not exceed 2 dB;
- d) circuitry associated with the RF coupling shall contain no active or non-linear devices;
- e) the VSWR at the 50  $\Omega$  socket shall not be more than 1,5 over the frequency range of the measurements;
- f) the coupling loss shall be independent of the position of the test fixture and be unaffected by the proximity of surrounding objects or people. The coupling loss shall be reproducible when the equipment under test is removed and replaced. Normally, the text fixture is in a fixed position and provides a fixed location for the EUT;
- g) the coupling loss shall remain substantially constant when the environmental conditions are varied.

The coupler attenuation of the test-fixture may amount to a maximum of the noise level of the measurement instrument +10 dB. If the attenuation is too high, a linear LNA can be used outside the test-fixture.

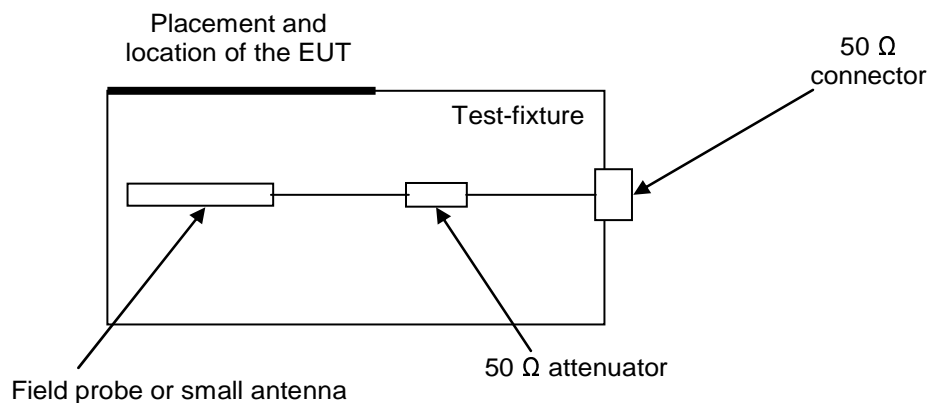

**Figure A.2: Test fixture**

The field probe (or small antenna) needs to be properly terminated.

The characteristics and validation shall be included in the test report.

### A.5.3.2.4.3 Validation of the Test Fixture in the Temperature Chamber

The test fixture is brought into a temperature chamber (only needed if test fixture measurements performed under extreme temperature conditions).

#### Step 1

A transmit antenna connected to a signal generator shall be positioned from the test-fixture at a far field distance of not less than one  $\lambda$  at the frequency. The test fixture consists of the mechanical support for the EUT, an antenna or field probe and a  $50\ \Omega$  attenuator for proper termination of the field probe. The test fixture shall be connected to a spectrum analyser via the  $50\ \Omega$  connector. A signal generator shall be set on the EUT's nominal frequency (see figure A.3). The unmodulated output power of the signal generator shall be set to a value such that a sufficiently high level can be observed with the spectrum analyser. This reference value shall be recorded in the test report. The signal generator shall then be set to the upper and the lower band limit of the EUT's assigned frequency band. The measured values shall not deviate more than 1 dB from the value at the nominal frequency.

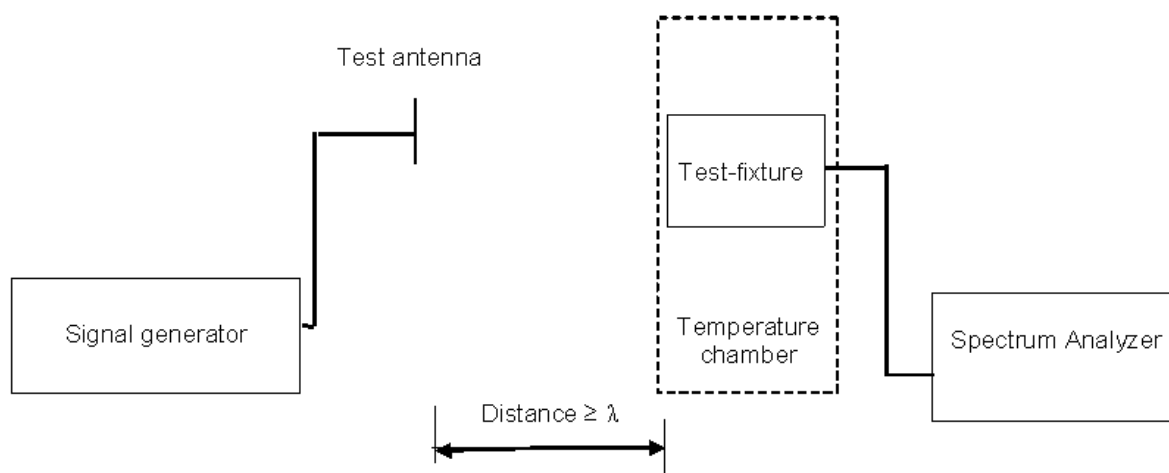

**Figure A.3: Validation of test fixture without EUT**

#### Step 2

During validation and testing the EUT shall be fitted to the test fixture in a switched-off mode, see figure A.4. The measurements of step 1 shall be repeated, this time with the EUT in place. The measured values shall be compared with those from step 1 and shall not vary by more than 2 dB. This shows that the EUT does not cause any significant shadowing of the radiated power.

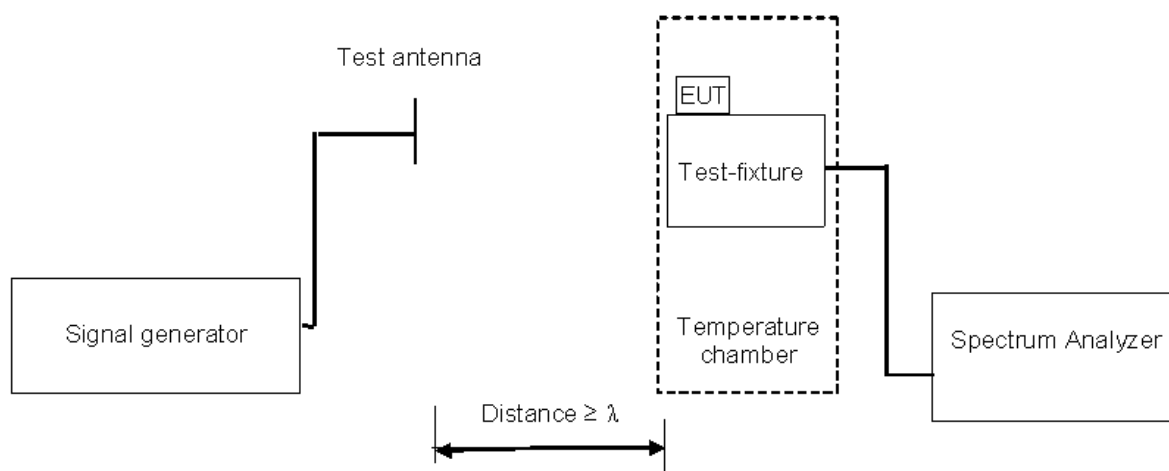

**Figure A.4: Validation of test fixture with EUT in place**

#### A.5.3.2.4.4 Use of the Test Fixture for Measurement in the Temperature Chamber

Here, the signal generator and the transmit antenna are removed. The EUT is dc supplied via an external power supply (see figure A.5). In case of a battery operated EUT that is supplied by a temporary power supply as well as temporary signal- and control line, a decoupling filter shall be installed directly at the EUT in order to avoid parasitic, electromagnetic radiation.

At the 50  $\Omega$  port of the test fixture, a measuring receiver is connected for recording the parameter of interest.

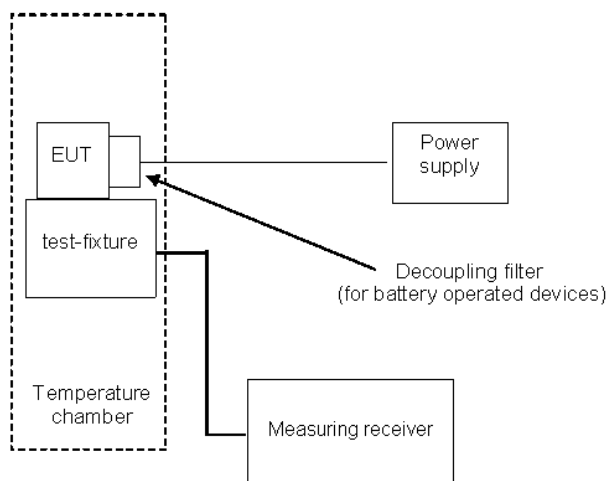

Figure A.5: Measurement of EUT performance in temperature chamber

---

## A.6 Choice of Equipment for Test Suites

### A.6.1 Choice of Model

The tests shall be carried out on one or more production models or equivalent preliminary models, as appropriate. If testing is performed on (a) preliminary model(s), then the corresponding production models shall be identical to the tested models in all respects relevant for the purposes of the present document.

### A.6.2 Presentation

Stand-alone equipment shall be tested complete with any ancillary equipment.

Plug-in radio devices may be tested together with a suitable test fixture and/or typical host equipment.

---

## A.7 Testing of Host Connected Equipment and Plug-In Radio Devices

### A.7.1 General

For combined equipment and for radio parts for which connection to or integration with host equipment is required to offer functionality to the radio, ETSI EG 203 367 [i.17], ETSI EN 303 446-1 [i.28] and ETSI EN 303 446-2 [i.29] provide necessary guidance for the assessment for such devices.

## A.7.2 The Use of a Host or Test Fixture for Testing Plug-In Radio Devices

Where the radio part is a plug-in radio device which is intended to be used within a variety of combinations, a suitable test configuration consisting of either a test fixture or typical host equipment shall be used. This shall be representative for the range of combinations in which the radio device may be used. The test fixture shall allow the radio equipment part to be powered and stimulated as if connected to or inserted into the host or combined equipment. Measurements shall be made to all requirements given in the relevant harmonised standards.

NOTE: For further information on this topic, see ETSI EG 203 367 [i.17].

## A.8 Interpretation of the measurement results

### A.8.1 General points on interpretation of the measurement results

The measurements described in the present document are based on the following assumptions:

- the measured value related to the corresponding limit will be used to decide whether an equipment meets the requirements of the present document;
- the value of the measurement uncertainty for the measurement of each parameter will be included in the test report; table A.1 below shows the recommended values for the maximum measurement uncertainty figures.

For the test methods, according to the present document, the measurement uncertainty figures are assumed to correspond to an expansion factor (coverage factor)  $k = 1,96$  or  $k = 2$  (which provide confidence levels of respectively 95 % and 95,45 % in the case where the distributions characterizing the actual measurement uncertainties are normal (Gaussian)). Principles for the calculation of measurement uncertainty are contained in ETSI TR 100 028 [i.18], in particular in annex D of the ETSI TR 100 028-2 [i.18].

Table A.1 is based on such expansion factors.

**Table A.1: Maximum measurement uncertainty**

Parameter	Maximum expanded measurement Uncertainty
Frequency stability	$\pm 1 \times 10^{-7}$
Frequency during RF power measurement	$\pm 1 \times 10^{-5}$
Radiated RF power (up to 40 GHz)	$\pm 6$ dB
Radiated RF power (above 40 GHz up to 66 GHz)	$\pm 8$ dB
Radiated RF power (above 66 GHz up to 100 GHz)	$\pm 10$ dB (see note 1)
Radiated RF power (above 100 GHz)	See note 2
Conducted RF power (up to 18 GHz)	$\pm 1,5$ dB
Conducted RF power (up to 40 GHz)	$\pm 2,5$ dB
Conducted RF power (up to 100 GHz)	$\pm 4$ dB
Conducted RF power (above 100 GHz)	See note 2
Temperature	$\pm 1$ °C
Time	$\pm 2$ %
Humidity	$\pm 5$ %
dc and low frequency voltages	$\pm 3$ %
NOTE 1: Achieved sensitivity and measurement uncertainty are a direct result of the chosen test suites. The values mentioned together with the concerns should therefore be considered illustrational rather than absolute for radiated measurements above 66 GHz, given the absence of some relevant information. For radiated emissions above 66 GHz the given measurement uncertainties are based on the assumption of the deployment of a cable based measurement set-up.	
NOTE 2: For measurements above 100 GHz, the expanded measurement uncertainty shall also be recorded in the test report and a detailed calculation shall be added. A future revision of the present document may include a value for frequencies above 100 GHz for expanded measurement uncertainty that is still under development.	



## A.8.2 Measurement uncertainty is equal to or less than maximum acceptable uncertainty

The interpretation of the results when comparing measurement values with specification limits shall be as follows:

- a) When the measured value does not exceed the limit value the equipment under test meets the requirements of the present document.
- b) When the measured value exceeds the limit value the equipment under test does not meet the requirements of the present document.
- c) The measurement uncertainty calculated by the test technician carrying out the measurement shall be recorded in the test report.
- d) The measurement uncertainty calculated by the test technician may be a maximum value for a range of values of measurement or may be the measurement uncertainty for the specific measurement undertaken. The method used shall be recorded in the test report.

## A.8.3 Measurement uncertainty is greater than maximum acceptable uncertainty

The interpretation of the results when comparing measurement values with specification limits should be as follows:

- a) When the measured value plus the difference between the measurement uncertainty calculated by the test technician and the maximum acceptable measurement uncertainty does not exceed the limit value, the equipment under test meets the requirements of the present document.
- b) When the measured value plus the difference between the measurement uncertainty calculated by the test technician and the maximum acceptable measurement uncertainty exceeds the limit value the equipment under test does not meet the requirements of the present document.
- c) The measurement uncertainty calculated by the test technician carrying out the measurement shall be recorded in the test report.
- d) The measurement uncertainty calculated by the test technician may be a maximum value for a range of values of measurement or may be the measurement uncertainty for the specific measurement undertaken. The method used shall be recorded in the test report.

---

## Annex B (normative): Test setups

### B.1 Introduction

In this clause the required test setups, test antennas and test methods for the testing of SRD and UWB devices are described. Two test setups are provided:

- radiated measurements, see clause B.2; and
- conducted measurements for equipment providing a 50  $\Omega$  antenna connector, see clause B.3.

---

### B.2 Radiated measurements

#### B.2.1 General

The following information for radiated measurements is provided in clause B.2:

- Clause B.2.2: Test sites and test antennas used for radiated measurements
- Clause B.2.3: Guidance on the use of a radiation test site
- Clause B.2.4: Information on the coupling of signals
- Clause B.2.5: Standard test methods used for radiated measurements

A more detailed descriptions of radiated measurement arrangements for UWB radio devices can be found in Recommendation ITU-R SM.1754-0 [i.19].

All reasonable efforts should be made to clearly demonstrate that emissions from the UWB and SRD transmitter do not exceed the specified levels, with the transmitter in the far field. To the extent practicable, the radio device under test shall be measured at the distance specified in clause B.2.3.5 and with the specified measurement bandwidths. However, in order to obtain an adequate signal-to-noise ratio in the measurement system, radiated measurements may have to be made at distances less than those specified in clause B.2.3.5 and/or with reduced measurement bandwidths.

The revised measurement configuration should be stated on the test report, together with an explanation of why the signal levels involved necessitated measurement at the distance employed or with the measurement bandwidth used in order to be accurately detected by the measurement equipment and calculations demonstrating compliance.

Where it is not practical to further reduce the measurement bandwidth either because of limitations of commonly-available test equipment or difficulties in converting readings taken using one measurement bandwidth to those used by the limits given in the relevant harmonised standard, and the required measurement distance would be so short that the radio device would not clearly be within the far field, the test report shall state this fact, the measurement distance and bandwidth used, the near field/far field distance for the measurement setup (see clause B.2.3.5), the measured radio device emissions, the achievable measurement noise floor and the frequency range(s) involved.

#### B.2.2 Test Sites and General Arrangements for Measurements Involving the Use of Radiated Fields

##### B.2.2.1 General

This clause introduces the test site which may be used for radiated tests. The test site is generally referred to as a free field test site. Both absolute and relative measurements can be performed in these sites. Where absolute measurements are to be carried out, the chamber should be verified. A detailed verification procedure is described in ETSI TS 102 321 [2].

### B.2.2.2 Anechoic Chamber

An anechoic chamber is the preferred test site to be used for radiated testing in accordance with the present document above 1 GHz. However, an anechoic chamber with ground plane as described in clause B.2.2.3 may be used above 1 GHz providing that suitable anechoic material is placed on the chamber floor to suppress any reflected signal.

An anechoic chamber is an enclosure, usually shielded, whose internal walls, floor and ceiling are covered with radio absorbing material, normally of the pyramidal urethane foam type. The chamber usually contains an antenna support at one end and a turntable at the other. A typical anechoic chamber is shown in figure B.1.

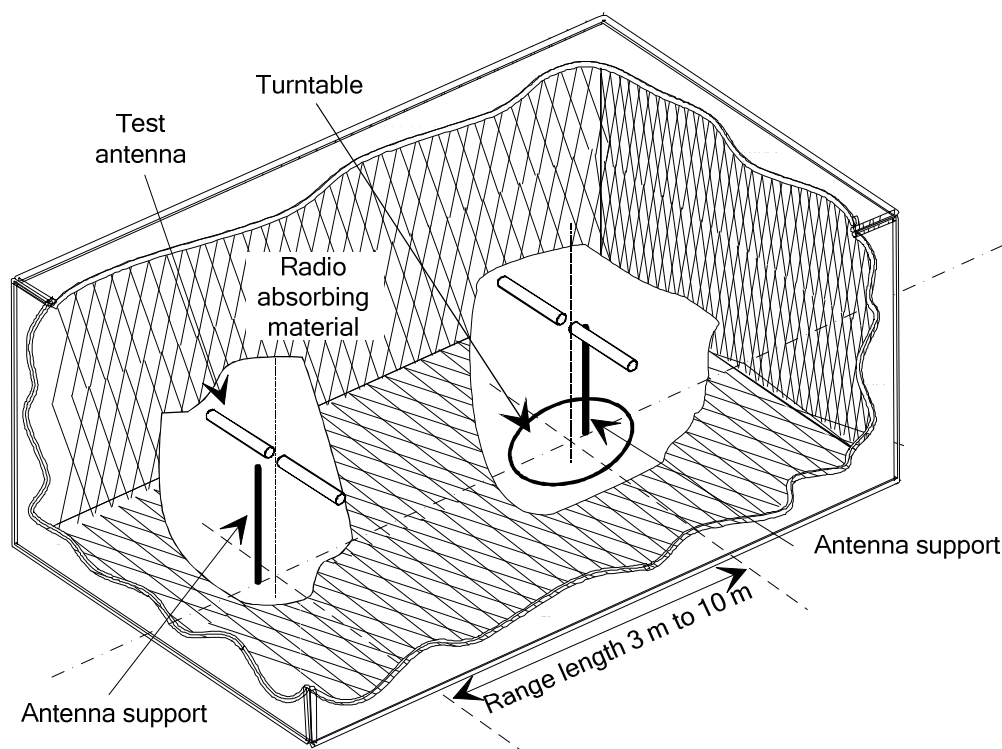

**Figure B.1: A typical anechoic chamber**

The chamber shielding and radio absorbing material work together to provide a controlled environment for testing purposes. This type of test chamber attempts to simulate free space conditions.

The shielding provides a test space, with reduced levels of interference from ambient signals and other outside effects, whilst the radio absorbing material minimizes unwanted reflections from the walls and ceiling which can influence the measurements. In practice it is relatively easy for shielding to provide high levels (80 dB to 140 dB) of ambient interference rejection, normally making ambient interference negligible.

A turntable is capable of rotation through 360° in the horizontal plane and it is used to support the test sample (EUT) at a suitable height (e.g. 1 m) above the ground plane. The chamber shall be large enough to allow the measuring distance of at least 3 m or  $2(d_1 + d_2)^2/\lambda$  (m), whichever is greater (see clause B.2.3.5). However, it shall be noted that due to the low radiated power density for UWB equipment, its transmit spectrum can be measured at approximately 1 m to improve measurement sensitivity. The distance used in actual measurements shall be recorded with the test results. Practical tests have shown that larger measurement distances of up to 3 meters at the frequencies below 1 GHz and shorter measurement distances of less than 1 meter at frequencies above 10 GHz can be implemented as long as the far field conditions are still fulfilled.

The anechoic chamber generally has several advantages over other test facilities. There is minimal ambient interference, minimal floor, ceiling and wall reflections, and it is independent of the weather. It does however have some disadvantages which include limited measuring distance and limited lower frequency usage due to the size of the pyramidal absorbers. To improve low frequency performance, a combination structure of ferrite tiles and urethane foam absorbers is commonly used.

All types of emission testing can be carried out within an anechoic chamber without limitation.

### B.2.2.3 Anechoic Chamber with a Conductive Ground Plane

An anechoic chamber with a conductive ground plane shall be used for radiated testing in accordance with the present document below 1 GHz.

An anechoic chamber with a conductive ground plane is an enclosure, usually shielded, whose internal walls and ceiling are covered with radio absorbing material, normally of the pyramidal urethane foam type. The floor, which is metallic, is not covered and forms the ground plane. The chamber usually contains an antenna mast at one end and a turntable at the other. A typical anechoic chamber with a conductive ground plane is shown in figure B.2.

This type of test chamber attempts to simulate an ideal Open Area Test Site whose primary characteristic is a perfectly conducting ground plane of infinite extent.

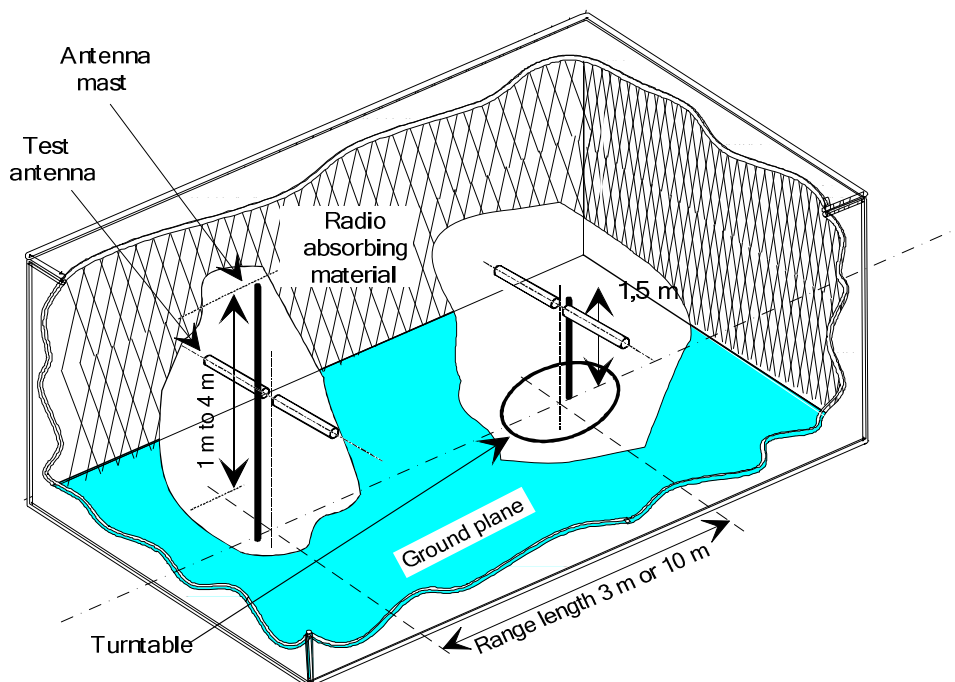

**Figure B.2: A typical anechoic chamber with a conductive ground plane**

In this facility the ground plane creates the wanted reflection path, such that the signal received by the receiving antenna is the sum of the signals from both the direct and reflected transmission paths. This creates a unique received signal level for each height of the transmitting antenna (or EUT) and the receiving antenna above the ground plane.

The antenna mast provides a variable height facility (from 1 m to 4 m) so that the position of the test antenna can be optimized for maximum coupled signal between antennas or between a EUT and the test antenna.

A turntable is capable of rotation through  $360^\circ$  in the horizontal plane and it is used to support the test sample (EUT) at a specified height, usually 1,5 m above the ground plane. The chamber shall be large enough to allow the measuring distance of at least 3 m or  $2(d_1 + d_2)^2 / \lambda$  (m), whichever is greater (see clause B.2.3.5). However, it shall be noted that due to the low radiated power density for some equipment (e.g. UWB) its transmit spectrum can only be measured at approximately 1 m. The distance used in actual measurements shall be recorded with the test results.

Emission testing involves firstly searching for the maximum field strength from the EUT by raising and lowering the receiving antenna on the mast (to obtain the maximum constructive interference of the direct and reflected signals from the EUT) at every azimuth position by using a turntable. At the position of maximum field strength, the amplitude of the received signal at the measuring receiver is noted. Secondly the EUT is replaced by a substitution antenna (positioned at the EUT's phase or volume centre), which is connected to a signal generator. The signal generator output will be adjusted until the level at the measuring receiver is at the same level as noted in stage one.

### B.2.2.4 Open Area Test Site (OATS)

An Open Area Test Site comprises a turntable at one end and an antenna mast of variable height at the other end above a ground plane, which in the ideal case, is perfectly conducting and of infinite extent. In practice, whilst good conductivity can be achieved, the ground plane size has to be limited. A typical OATS is shown in figure B.3.

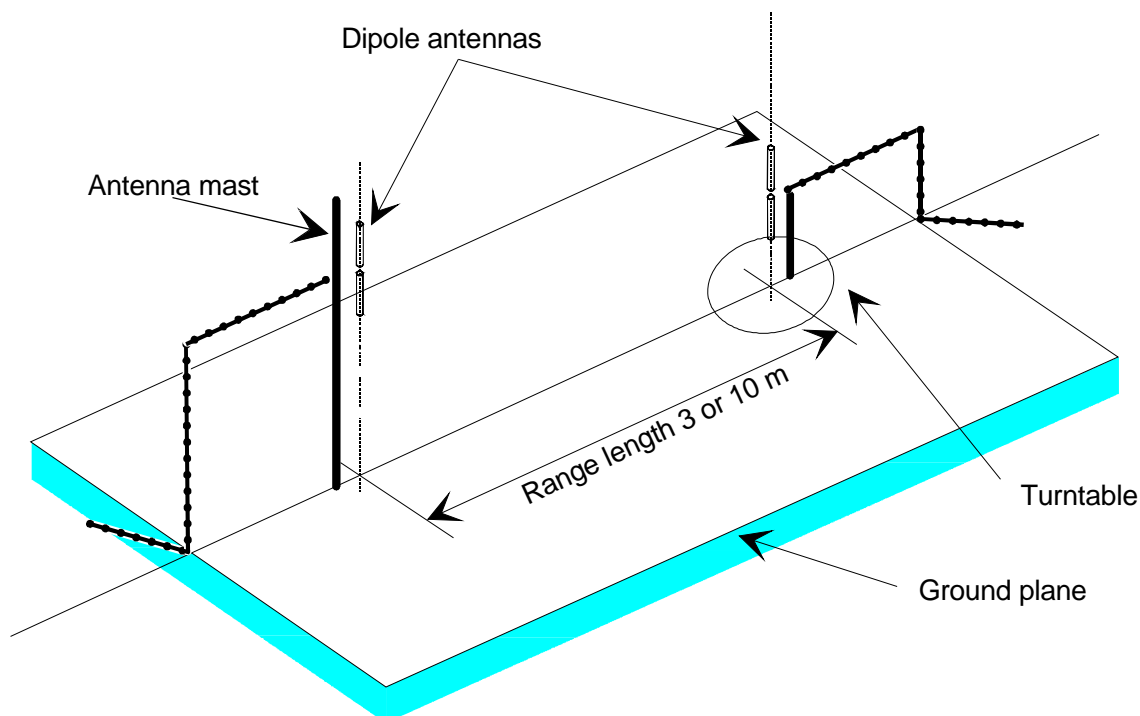
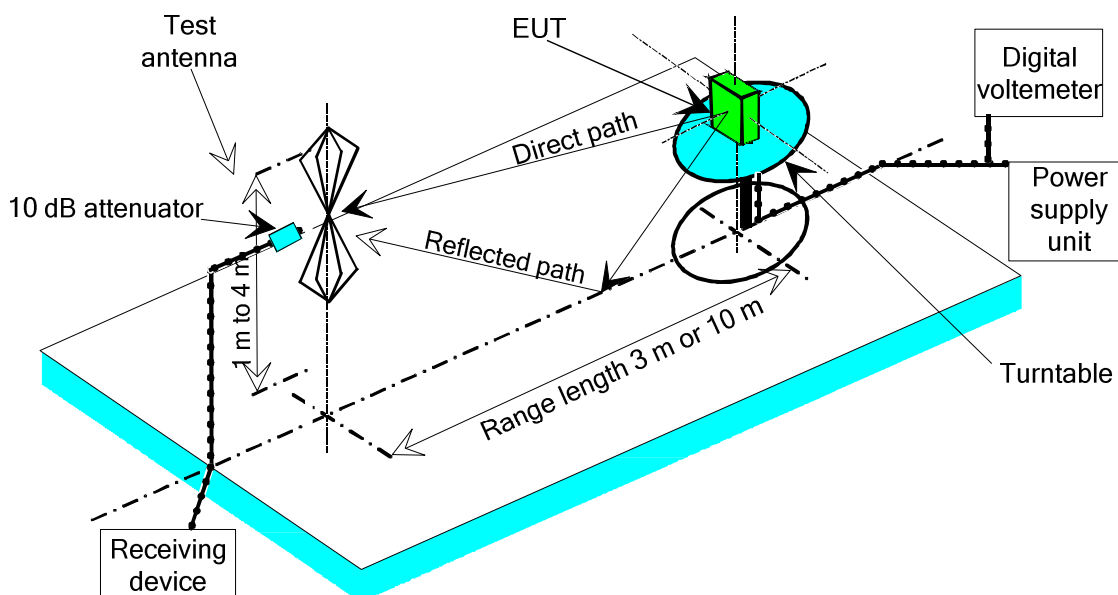

**Figure B.3: A typical Open Area Test Site**

The ground plane creates a wanted reflection path, such that the signal received by the receiving antenna is the sum of the signals received from the direct and reflected transmission paths. The phasing of these two signals creates a unique received level for each height of the transmitting antenna (or EUT) and the receiving antenna above the ground plane.

Site qualification concerning antenna positions, turntable, measurement distance and other arrangements are same as for anechoic chamber with a ground plane. In radiated measurements an OATS is also used by the same way as anechoic chamber with a ground plane.

Typical measuring arrangement common for ground plane test sites is presented in figure B.4.



**Figure B.4: Measuring arrangement on ground plane test site (OATS set-up for spurious emission testing)**

### B.2.2.5 Test Antenna

A test antenna is always used in radiated test methods. In emission tests (i.e. effective radiated power, spurious emissions) the test antenna is used to detect the field from the EUT in one stage of the measurement and from the substitution antenna in the other stage. When the test site is used for the measurement of receiver characteristics (i.e. sensitivity and various immunity parameters) the antenna is used as the transmitting radio device.

The test antenna should be mounted on a support capable of allowing the antenna to be used in either horizontal or vertical polarization which, on ground plane sites (i.e. anechoic chambers with ground plane) should additionally allow the height of its centre above the ground to be varied over the specified range (usually 1 m to 4 m).

In the frequency band 30 MHz to 1 000 MHz, dipole antennas (constructed in accordance with ANSI C63.5 [i.20]) are generally recommended. For frequencies of 80 MHz and above, the dipoles should have their arm lengths set for resonance at the frequency of test. Below 80 MHz, shortened arm lengths are recommended. For spurious emission testing, however, a combination of bicones and log periodic dipole array antennas (commonly termed "log periodic") could be used to cover the entire 30 MHz to 1 000 MHz band. Above 1 000 MHz, waveguide horns are recommended although, again, log periodic could be used.

NOTE: The gain of a horn antenna is generally expressed relative to an isotropic radiator.

### B.2.2.6 Substitution Antenna

The substitution antenna is used to replace the EUT for tests in which a transmitting parameter (i.e. frequency error, effective radiated power, spurious emissions and adjacent channel power) is being measured. For measurements in the frequency band 30 MHz to 1 000 MHz, the substitution antenna should be a dipole antenna (constructed in accordance with ANSI C63.5 [i.20]). For frequencies of 80 MHz and above, (resonant) dipoles should have their arm lengths set for resonance at the frequency of test. Below 80 MHz, shortened arm lengths are recommended (when resonant dipoles are used). For measurements above 1 000 MHz, a waveguide horn is recommended. For broadband dipoles, such as ANSI C63.5-compliant [i.20] or CISPR 16-1-6 [i.33] biconical antennas, such adjustment is unnecessary.

### B.2.2.7 Measuring Antenna

The measuring antenna is used in tests on a EUT in which a receiving parameter (i.e. sensitivity and various immunity tests) is being measured. Its purpose is to enable a measurement of the electric field strength in the vicinity of the EUT. For measurements in the frequency band 30 MHz to 1 000 MHz, the measuring antenna should be a dipole antenna (constructed in accordance with ANSI C63.5 [i.20]). For frequencies of 80 MHz and above, the dipoles should have their arm lengths set for resonance at the frequency of test. Below 80 MHz, shortened arm lengths are recommended. The centre of this antenna should coincide with either the phase centre or volume centre (as specified in the test method) of the EUT.

### B.2.2.8 Minimum Requirements for Test Sites for Measurements above 18 GHz

Generally, the test site shall be adequate to allow for testing in the far field of the EUT. The test site should therefore consist of an electromagnetic anechoic room where either at least the ground surface is covered with radio absorbing material or up to six surrounding surfaces are covered with radio absorbing material. The absorbing material shall have a minimum attenuation of 30 dB. It shall be verified that reflections are sufficiently reduced. The test site shall have the following dimensions:

- Width of 2 m.
- Length of 3 m.
- Height of 2 m (only applicable for a room with more than one reflecting surface).

Highly directional receiving antennas help in reducing reflections. The use of standard gain horn antennas is recommended. It shall be noted that if the antenna aperture is smaller than the EUT, sufficient measurements in both azimuth and elevation shall be conducted in order to ensure that the maximum radiation is determined.

The measuring distance shall be selected in such way that antenna coupling effects are avoided. A distance of at least 0,5 m is therefore recommended. The EUT may be positioned at any height that minimizes reflections from the floor.

Due to high loss of coaxial cables at higher frequencies, the connection from the receiving antenna to the measuring receiver should not exceed 1 m, thus making it necessary to place the measuring receiver very close. This is especially the case when using external harmonic mixers with very short connections to the measuring receiver. Therefore, the measuring receiver should somehow be covered with radio absorbing material in direction to the measuring field in order to reduce reflections. Figure B.5 shows an example of a test site above 18 GHz with one reflecting surface.

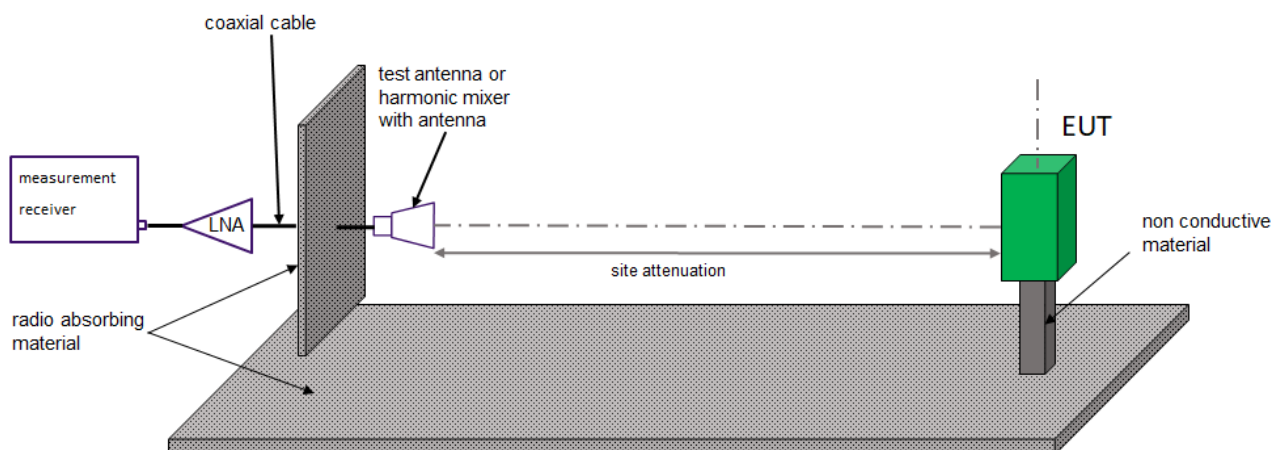

**Figure B.5: Example of a test site above 18 GHz with one reflecting surface**

The site attenuation of the test site can be determined. Should the test site in its characteristics be nearly ideal, it may be possible to use the theoretical Free Space Loss (FSL, see formula (B.1)) as site attenuation as shown in the examples in table B.1, table B.2 and table B.3.

**Table B.1: Example of Free Space Loss at 1 m distance**

Measuring distance/m	F [GHz]	$\lambda$ [m]	FSL [dB]
1	24,2	0,012397	60,12
	48,4	0,006198	66,14
	72,6	0,004132	69,66
	96,8	0,003099	72,16

**Table B.2: Example of Free Space Loss at 0,5 m distance**

Measuring distance/m	F [GHz]	$\lambda$ [m]	FSL [dB]
0,5	24,2	0,012397	54,1
	48,4	0,006198	60,12
	72,6	0,004132	63,64
	96,8	0,003099	66,14

**Table B.3: Example of Free Space Loss at 0,25 m distance**

Measuring distance/m	F [GHz]	$\lambda$ [m]	FSL [dB]
0,25	72,6	0,004132	57,62
	96,8	0,003099	60,12

$$FSL = 20 \log \left( \frac{4\pi r}{\lambda} \right) \quad (\text{B.1})$$

Whereas wavelength:

$$\lambda = \frac{c}{f} \quad (\text{B.2})$$

## B.2.3 Guidance on the Use of a Radiation Test Site

### B.2.3.1 General on Guidance on the Use of a Radiation Test Site

This clause details procedures, test equipment arrangements and verification that should be carried out before any of the radiated tests are undertaken.

### B.2.3.2 Verification of the Test Site

No test should be carried out on a test site which does not possess a valid certificate of verification. The verification procedures for the different types of test sites described in clause B.1 (i.e. anechoic chamber and anechoic chamber with a ground plane) are given in the relevant parts of ETSI TR 102 273 [i.21] or equivalent.

### B.2.3.3 Preparation of the EUT

The manufacturer should supply information about the EUT covering the operating frequency, polarization, supply voltage(s) and the reference face. Additional information, specific to the type of EUT should include, where relevant, carrier power, channel separation, whether different operating modes are available (e.g. high and low power modes) and if operation is continuous or is subject to a maximum test duty cycle (e.g. 1 minute on, 4 minutes off).

Where necessary, a mounting bracket of minimal size should be available for mounting the EUT on the turntable. This bracket should be made from low conductivity, low relative dielectric constant (i.e. less than 1,5) material(s) such as expanded polystyrene, balsawood, etc.



### B.2.3.4 Power Supplies to the EUT

Where possible, all tests should be performed using power supplies, including tests on EUT designed to include battery-only use. However, devices may be tested with internal batteries in that casing materials, components, and sealants used for assembly, can affect test results.

If a battery supply is used, fully-charged batteries shall be used. The batteries used shall be as supplied or recommended by the manufacturer. If internal batteries are used, at the end of each test the voltage shall be within a tolerance of  $\pm 5\%$  relative to the voltage at the beginning of each test. If the battery is not accessible (for example, it is internal to a sealed unit), then it is acceptable to determine the battery voltage at the start and end of the test by indirect means (e.g. battery health messages sent from the unit itself). In all cases, in which power leads are used, they should be connected to the EUT's supply terminals (and monitored with a digital voltmeter) but the battery should remain present, electrically isolated from the rest of the equipment, possibly by putting tape over its contacts.

The presence of these power cables can, however, affect the measured performance of the EUT. For this reason, they should be made to be "transparent" as far as the testing is concerned. This can be achieved by routing them away from the EUT and down to either the screen, ground plane or facility wall (as appropriate) by the shortest possible paths. Precautions should be taken to minimize pick-up on these leads (e.g. the leads could be twisted together, loaded with ferrite beads at 0,15 m spacing or otherwise loaded).

### B.2.3.5 Range Length

#### B.2.3.5.1 General

The range length for all these types of test facility should be adequate to allow for testing in the far field of the EUT i.e. it should be equal to or exceed:

$$\frac{2(d_1+d_2)^2}{\lambda} \quad (\text{B.3})$$

Where:

$d_1$  is the largest dimension of the EUT/dipole after substitution (m);

$d_2$  is the largest dimension of the test antenna (m);

$\lambda$  is the test frequency wavelength (m).

It should be noted that in the substitution part of this measurement, where both test and substitution antennas are half wavelength dipoles, this minimum range length for far-field testing would be:

$$2\lambda \quad (\text{B.4})$$

It should be noted in test reports when either of these conditions is not met so that the additional measurement uncertainty can be incorporated into the results.

NOTE 1: For the fully anechoic chamber, no part of the volume of the EUT should, at any angle of rotation of the turntable, fall outside the "quiet zone" of the chamber at the nominal frequency of the test.

NOTE 2: The "quiet zone" is a volume within the anechoic chamber (without a ground plane) in which a specified performance has either been proven by test or is guaranteed by the designer/manufacturer. The specified performance is usually the reflectivity of the absorbing panels or a directly related parameter (e.g. signal uniformity in amplitude and phase). It should be noted however that the defining levels of the quiet zone tend to vary.

#### B.2.3.5.2 Practical Test Distances for Accurate Measurements

It may not be possible to measure at the power limits without low-noise amplification to reduce the overall noise figure of the overall measurement system at a separation of approximately 3 m in an RF quiet environment. A move to lower separation distance or reduced measurement bandwidth may be required since the instrumentation noise floor should be below the limit within the instrument bandwidth.

The far field condition may imply impossible distances for accurate measurement of power limits or conventional antenna-pattern. For this purpose, a lower distance limit is discussed. Smaller distances can be used without loss of accuracy as long as the measurements are restricted to maximum power or amplitude.

A measurement of radiated power is made in front of an antenna. If the measurements are made too close to an antenna this will result in erroneous power readings. To avoid this, a minimum distance for antenna pattern measurements in an anechoic chamber should be in accordance with table B.4.

**Table B.4: Uncertainty contribution: range length (test methods) according to ETSI TR 102 215 [i.22]**

Range length (i.e. the horizontal distance between phase centres)	Standard uncertainty of the contribution
$(d_1 + d_2)^2/4\lambda \leq \text{range length} < (d_1 + d_2)^2/2\lambda$	1,26 dB
$(d_1 + d_2)^2/2\lambda \leq \text{range length} < (d_1 + d_2)^2/\lambda$	0,30 dB
$(d_1 + d_2)^2/\lambda \leq \text{range length} < 2(d_1 + d_2)^2/\lambda$	0,10 dB
$\text{range length} \geq 2(d_1 + d_2)^2/\lambda$	0,00 dB
NOTE: $d_1$ and $d_2$ are the maximum dimensions of the EUT and the test antenna, used in one stage and are the maximum dimensions of the two antennas in the other stage.	

Two or even four times distance reduction may be applied. A further reduction will cause severe decrease of the accuracy. Further information can be found in ETSI TR 102 215 [i.22].

### B.2.3.6 Site Preparation

The cables for both ends of the test site should be routed horizontally away from the testing area for a minimum of 2 m and then allowed to drop vertically and out through either the ground plane or screen (as appropriate) to the test equipment. Precautions should be taken to minimize pick up on these leads (e.g. dressing with ferrite beads, or other loading). The cables, their routing and dressing should be identical to the verification set-up.

Calibration data for all items of test equipment should be available and valid. For test, substitution and measuring antennas, the data should include gain relative to an isotropic radiator (or antenna factor) for the frequency of test. Also, the VSWR of the substitution and measuring antennas should be known.

The calibration data on all cables and attenuators should include insertion loss and VSWR throughout the entire frequency range of the tests. All VSWR and insertion loss figures should be recorded in the logbook results sheet for the specific test.

Where correction factors/tables are required, these should be immediately available.

For all items of test equipment, the maximum measurement uncertainty they exhibit should be known along with the distribution of the uncertainty.

At the start of measurements, system checks should be made on the items of test equipment used on the test site.

## B.2.4 Coupling of Signals

### B.2.4.1 General

The presence of leads in the radiated field may cause a disturbance of that field and lead to additional measurement uncertainty. These disturbances can be minimized by using suitable coupling methods, offering signal isolation and minimum field disturbance (e.g. optical and acoustic coupling).

## B.2.4.2 Data Signals

Isolation can be provided by the use of optical, ultrasonic or infrared means. Field disturbance can be minimized by using a suitable fibre optic connection. Ultrasonic or infrared radiated connections require suitable measures for the minimization of ambient noise.

## B.2.5 Standard Radiated Test Methods

### B.2.5.0 Initial Measurement Steps

In a first step the relevant frequency band for the measurement of the System under test has to be identified by using the product information from clause A.2 and a coarse peak power measurement using a spectrum analyser. After the identification of the relevant band of the EUT the further measurement steps can be performed. The identification step is independent of the system to be measured and the measurement to be performed (mean power or peak power, radiated or conducted).

The settings of the instrument have to be chosen based on the description of the signal provided, so as to ensure that the highest values of peak power and mean PSD are captured. This is particularly important for a scanning instrument (spectrum analyser) and a signal that has complex variation in time or over frequency. It is suggested that the signal should initially be observed with both peak and mean measuring modes, over its full bandwidth, to confirm the description and to establish where the highest values can and cannot be in RF. This will permit subsequent measurements to be made with a narrower RF span. Where there is any doubt about the effect of frequency scanning, a measurement at a single RF (zero spans) will provide confirmation.

### B.2.5.1 General Information on Test Methods

Two methods of determining the radiated power of a radio device are described in clause B.2.5.2 (calibrated setup) and clause B.2.5.3 (substitution method).

### B.2.5.2 Calibrated Setup

The measurement receiver, test antenna and all associated equipment (e.g. cables, filters, amplifiers, etc.) shall have been recently calibrated against known standards at all the frequencies on which measurements of the equipment are to be made. A suggested calibration method is given in clause B.2.6.

A test site according to clause B.2.2 shall be selected based on the guidance in clause B.2.3. The equipment shall be placed at the specified height on a support, and in the position closest to normal use of the EUT.

The test antenna shall be oriented initially for vertical polarization and shall be chosen to correspond to the frequency of the transmitter.

The output of the test antenna shall be connected to the spectrum analyser via whatever (fully characterized) equipment is required to render the signal measurable (e.g. amplifiers).

The transmitter shall be switched on, if possible, without modulation, and the spectrum analyser shall be tuned to the frequency of the transmitter under test.

The test antenna shall be raised and lowered through the specified range of height until a maximum signal level is detected by the spectrum analyser.

The transmitter shall then be rotated through 360° in the horizontal plane, until the maximum signal level is detected by the spectrum analyser.

The test antenna shall be raised and lowered again through the specified range of height until a maximum signal level is detected by the spectrum analyser.

The maximum signal level detected by the spectrum analyser shall be noted and converted into the radiated power by application of the pre-determined calibration coefficients for the equipment configuration used.

NOTE: The calibration procedure is to be performed with both polarizations: vertical and horizontal.

### B.2.5.3 Substitution Method

A test site according to clause B.2.2 shall be selected based on the guidance in clause B.2.3. The equipment shall be placed at the specified height on a support, and in the position closest to normal use of the EUT. The test antenna shall be oriented initially for vertical polarization and shall be chosen to correspond to the frequency of the transmitter.

The output of the test antenna shall be connected to the spectrum analyser.

The transmitter shall be switched on, if possible, without modulation, and the measuring receiver shall be tuned to the frequency of the transmitter under test.

The test antenna shall be raised and lowered through the specified range of height until a maximum signal level is detected by the spectrum analyser.

The transmitter shall then be rotated through 360° in the horizontal plane, until the maximum signal level is detected by the spectrum analyser.

The test antenna shall be raised and lowered again through the specified range of height until a maximum signal level is detected by the spectrum analyser.

The maximum signal level detected by the spectrum analyser shall be noted.

The transmitter shall be replaced by a substitution antenna as defined in clause B.2.2.6.

The substitution antenna shall be orientated for vertical polarization and the length of the substitution antenna shall be adjusted to correspond to the frequency of the transmitter.

The substitution antenna shall be connected to a calibrated signal generator.

If necessary, the input attenuator setting of the spectrum analyser shall be adjusted in order to increase the sensitivity of the spectrum analyser.

The test antenna shall be raised and lowered through the specified range of height to ensure that the maximum signal is received. When a test site according clause B.2.2.2 is used, the height of the antenna shall not be varied.

The input signal to the substitution antenna shall be adjusted to the level that produces a level detected by the spectrum analyser, that is equal to the level noted while the transmitter radiated power was measured, corrected for the change of input attenuator setting of the spectrum analyser.

The input level to the substitution antenna shall be recorded as power level, corrected for any change of input attenuator setting of the spectrum analyser.

The measurement shall be repeated with the test antenna and the substitution antenna orientated for horizontal polarization.

The measure of the radiated power of the radio device is the larger of the two levels recorded at the input to the substitution antenna, corrected for gain of the substitution antenna if necessary.

### B.2.6 Standard calibration method

The calibration of the test fixture establishes the relationship between the detected output from the test fixture, and the transmitted power (as sampled at the position of the antenna) from the EUT in the test fixture. This can be achieved (at higher frequencies) by using a calibrated horn with a gain of equal to or less than 22 dBi, fed from an external signal source, in place of the EUT to determine the variations in detected power over frequency.

The calibration setup is shown in figure B.6.

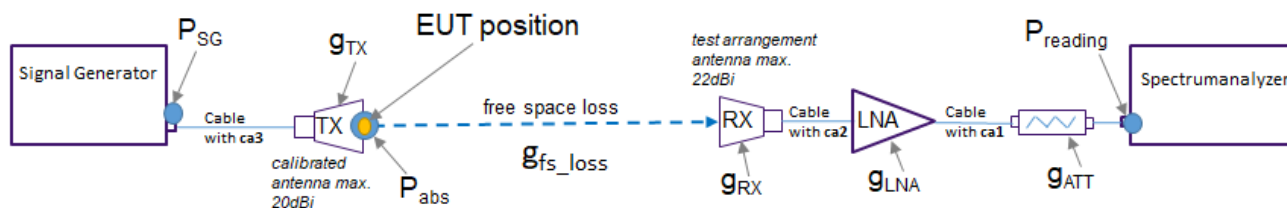

**Figure B.6: Calibration set-up configuration**

The calibration of the test fixture shall be carried out by either the provider or the accredited test laboratory. The results shall be approved by the accredited test laboratory.

It is the responsibility of the tester to obtain enough measurement accuracy. The following description is an example of a proven and accurate calibration method:

- a) Calibrate all instruments using usual calibration routines.
- b) Remove the EUT from the test fixture and replace the EUT by a calibrated antenna. Carefully orientate the calibration antenna in the test fixture towards the test arrangement antenna. The reference plane of the calibration antenna shall coincide with the EUT reference plane. The distance between the calibration antenna and the test arrangement antenna shall be between 0,5 m to 1 m.
- c) Connect a signal generator to the calibrated antenna in the test fixture.
- d) Connect a 10 dB attenuator to the test arrangement antenna to improve the VSWR. If SNR of the test arrangement is low it might be necessary to omit the attenuator.
- e) Connect a power meter to the test arrangement antenna including a 10 dB attenuator, if required, and apply, by means of a signal generator, a frequency and power level to the same as the expected value from the EUT output to the calibration antenna in the test fixture.
- f) Take into account the gain from both the calibration and the test arrangement antenna, the losses from the attenuator and all cables in use and the gain of an LNA, if required.
- g) Note the absolute reading of the power meter.
- h) Replace the power meter with a spectrum analyser. Adjust the frequency and power level of the signal generator to the same as the expected value from the EUT output. Apply this signal to the calibration antenna.
- i) Take into account the gain from both the calibration and the test arrangement antenna, the losses from the attenuator and all cables in use and the gain of an LNA, if required. Instead of an external attenuator the built-in attenuator of the spectrum analyser may be used.
- j) Set the spectrum analyser detector in RMS mode with an RBW and VBW at least as large as the signal generator output signal bandwidth with an appropriate spectrum analyser sweep rate. Note the absolute reading of the spectrum analysers input signal.
- k) The noted absolute power reading of the power meter and the spectrum analyser shall not differ more than the specified uncertainty of the used measurement equipment.
- l) Calculate the total attenuation from the EUT reference plane to the spectrum analyser as follows:

$P_{\text{reading}}$  = the absolute power level (in e.g. dBm) noted from the power meter/spectrum analyser.

$g_{\text{Tx}}$  = antenna gain in dB of the calibrated antenna in the test fixture.

$g_{\text{Rx}}$  = antenna gain in dB of the test arrangement antenna.

$g_{\text{ATT}}$  = the 10 dB attenuator loss (0 dB, if attenuator not used).

$\sum ca$  = the total loss in dB of all cables used in the test setup.

$g_{\text{LNA}}$  = the gain in dB of the low noise amplifier (0 dB, if LNA not used).

$g_{fs\_loss}$  = the free space loss in dB between the calibrated antenna (TX) in the test fixture and the test arrangement antenna (RX).

$c_{ATT}$  = calculated attenuation in dB of all losses with referenced to the EUT position.

$P_{abs}$  = the absolute power (in e.g. dBm) of the EUT (e.i.r.p.).

$c_{ATT} = g_{fs\_loss} - g_{RX} + g_{cable2} - g_{LNA} + \sum ca + g_{ATT}$ .

$P_{abs} = P_{reading} - c_{ATT}$ .

The calibration should be carried out at a minimum of three frequencies within the operating frequency band.

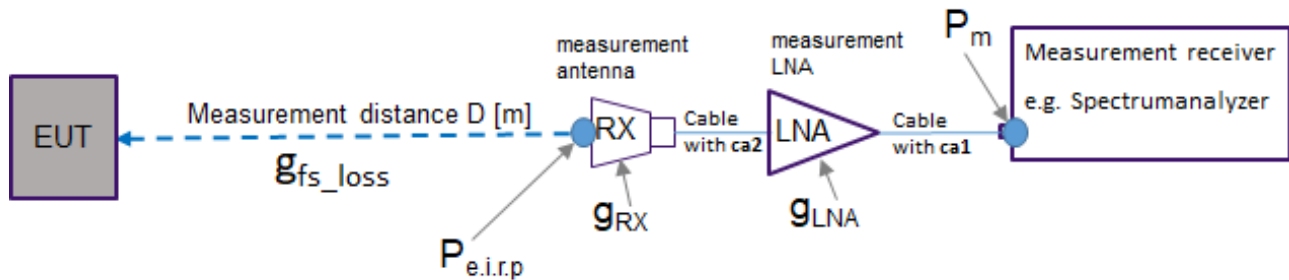

**Figure B.7: Test set-up for measuring the operating frequency range**

Where:

- $g_{RX}$ : Gain of the measurement antenna in [dB]
- $g_{LNA}$ : Gain of the measurement LNA [dB]
- $ca_1$ : Cable attenuation [dB]
- $ca_2$ : Cable attenuation [dB]
- $D$ : Measurement distance [m]
- $\lambda$ : Wave length of the radio signal;  $\frac{c}{f}$ ; [m]

Equation (Values [dB]):

$$P_{e.i.r.p} = P_m - g_{RX} + ca_2 + ca_1 - g_{LNA} + 20 \times \log\left(\frac{4 \times \pi \times D}{\lambda}\right) \quad (\text{B.5})$$

A test site such as one selected from annex A (i.e. indoor test site or open area test site), which fulfils the requirements of the specified frequency range and undisturbed lowest specified emission levels of this measurement shall be used.

## B.3 Conducted Measurements

Conducted measurements are permitted when specific prerequisites are fulfilled:

- Conducted measurements may be taken of equipment provided (permanently or temporarily) with a 50  $\Omega$  transmitter output connector.
- The maximum gain characteristics (across all directions) of the integral or dedicated antenna shall be provided as a function of frequency over the complete frequency range of measurement. If accurate measurement of the complete frequency range is impractical, then peak radiated e.i.r.p. compared to peak conducted power may be used as a gain value.

- The Voltage Standing Wave Ratio (VSWR) at the 50  $\Omega$  connector shall be measured and provided as a function of frequency over the complete frequency range of measurement.
- All ancillary equipment (e.g. amplifiers, cables) used in the measurement shall be calibrated over the complete frequency range of measurement.

In this case, the measured maximum antenna gain of the integral or dedicated antenna and any gains/losses (including those from impedance matching mismatch, see below) due to measurement equipment (e.g. amplifiers, cables) at each measurement frequency should be added to the conducted measurement to compute a radiated emission power level for each frequency which can be compared with the permitted limits given in the relevant standards, as below:

- Computed radiated level for frequency  $f$  =
- Measured conducted level at frequency  $f$  +
- Measured maximum antenna gain at frequency  $f$  +
- Mismatch loss at frequency  $f$  +
- ( $\Sigma$  Loss of cable(s) [if any] at frequency  $f$ ) -
- ( $\Sigma$  Gain of amplifier(s) [if any] at frequency  $f$ )

The mismatch loss at a particular frequency between the EUT and the measurement equipment can be determined from the measured VSWR at that frequency, as follows:

$$\rho = \frac{\Gamma - 1}{\Gamma + 1} \quad (\text{B.6})$$

$$L = -10 \log_{10}(1 - \rho^2) \quad (\text{B.7})$$

where:

$$\Gamma = VSWR \quad (\text{B.8})$$

with:

$$L = \text{Mismatch loss in dB}$$

Note that the above approach assumes that the antenna's gain characteristics have been determined as part of a 50  $\Omega$  system. In more complex cases where the antenna has not been characterized as a 50  $\Omega$  system, the mismatch calculations may be more involved - in these situations, full calculations and justification for those calculations shall be given in the test report.

## B.4 Detailed Information to Standard Test Methods

### B.4.1 Spherical Scan with Automatic Test Antenna Placement

#### B.4.1.1 General

Figure B.8 shows the spherical measurement method using automatic test antenna placement. The RX antenna is moveable and it is mounted for example on an automatic arm, which moves the antenna stepwise on a sphere around the EUT.

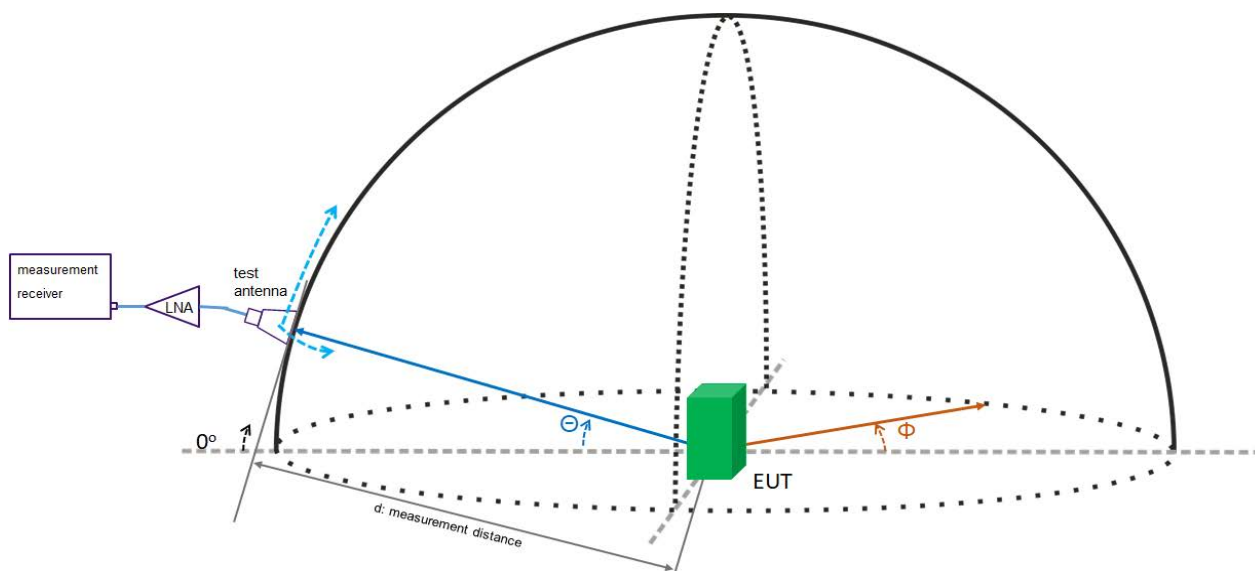

**Figure B.8: Spherical scan setup using automatic test antenna placement**

The maximum measurement step size for the azimuth angle  $\Phi$  and for the elevation angle  $\Theta$  is smaller or equal to  $15^\circ$ . In a half sphere scan  $\Phi$  is varied from  $0^\circ$  to  $360^\circ$  and  $\Theta$  is changed from  $0^\circ$  to  $90^\circ$ . Therefore, the EUT has to be mounted according to the typical usage in the application. If a full sphere scan shall be performed, then the device can be tilted by  $180^\circ$  and the half sphere shall be measured again. The scan shall be performed at a distance given by clause B.2.3.5.

NOTE: Another relation of the angles is possible, but the coverage of the whole spheres should be ensured.

### B.4.1.2 Calibrated Setup

The measurement receiver, test antenna and all associated equipment (e.g. cables, filters, amplifiers, etc.) shall have been recently calibrated against known standards at all the frequencies on which measurements of the equipment are to be made. A suggested calibration method is given in clause B.2.5.2.

If an anechoic chamber with conductive ground plane is used, the ground shall be covered by absorbing material in the area of the direct ground reflection from the EUT to the test antenna.

The equipment shall be placed in an anechoic chamber (compare clauses B.2.2.2 and B.2.2.3), which allows the spherical scan. The EUT shall be placed closest to the orientation of normal operation.

The test antenna shall be oriented initially for vertical polarization and shall be chosen to correspond to the frequency of the transmitter.

The output of the test antenna shall be connected to the spectrum analyser via whatever (fully characterized) equipment is required to render the signal measurable (e.g. amplifiers).

The transmitter shall be switched on, if possible, without modulation, and the spectrum analyser shall be tuned to the frequency of the transmitter under test.

The RX antenna shall be moved stepwise on the sphere and in each location the signal level shall be noted.

After all locations have been reached, the measurement procedure shall be repeated for horizontal polarized test antenna orientation.

The maximum signal level detected by the spectrum analyser shall be noted and converted into the radiated power by application of the pre-determined calibration coefficients for the equipment configuration used.

NOTE: "horizontal" and "vertical" polarization here refer to the initial polarizations of the antennas when they are situated at  $\theta = 0$  (i.e. with boresight parallel to the ground plane).



### B.4.1.3 Substitution Method

The equipment shall be placed in an anechoic chamber, which allows the spherical scan (compare clauses B.2.2.2 and B.2.2.3). The EUT shall be placed closest to the orientation of normal operation.

If an anechoic chamber with conductive ground plane is used, the ground shall be covered by absorbing material in the area of the direct ground reflection from the EUT to the test antenna.

The test antenna shall be oriented initially for vertical polarization and shall be chosen to correspond to the frequency of the transmitter.

The output of the test antenna shall be connected to the spectrum analyser.

The transmitter shall be switched on, if possible, without modulation, and the measuring receiver shall be tuned to the frequency of the transmitter under test.

The RX antenna shall be moved stepwise on the sphere and in each location the signal level and its coordinates shall be noted.

After all locations have been reached, the maximum signal level and its coordinates shall be determined.

The transmitter shall be replaced by a substitution antenna as defined in clause B.2.5.3.

The substitution antenna shall be orientated for vertical polarization.

The substitution antenna shall be connected to a calibrated signal generator.

If necessary, the input attenuator setting of the spectrum analyser shall be adjusted in order to increase the sensitivity of the spectrum analyser.

If an anechoic chamber with a conductive ground plane is used, then the substitution antenna shall be moved to the position of the previous maximum. The test antenna shall be moved around this position of the substitution antenna within at least five times the wavelength of the centre frequency on the sphere to find the local maximum.

The input signal to the substitution antenna shall be adjusted to the level that produces a level detected by the spectrum analyser, that is equal to the level noted while the transmitter radiated power was measured, corrected for the change of input attenuator setting of the spectrum analyser.

The input level to the substitution antenna shall be recorded as power level, corrected for any change of input attenuator setting of the spectrum analyser.

The measurement shall be repeated with the test antenna and the substitution antenna orientated for horizontal polarization.

The measure of the radiated power of the radio device is the larger of the two levels recorded at the input to the substitution antenna, corrected for gain of the substitution antenna if necessary.

NOTE: "horizontal" and "vertical" polarization here refer to the initial polarizations of the antennas when they are situated at  $\theta = 0$  (i.e. with boresight parallel to the ground plane).

### B.4.1.4 Spherical Scan with Rotating EUT

#### B.4.1.4.1 General

Instead of using an automatic arm, it is also possible to rotate ( $\Phi$  from  $0^\circ$  to  $360^\circ$ ) and tilt (via  $\Theta$ ) the EUT (see figure B.9). Thus, the same sphere can be measured as with the automatic arm. In contrast to the previous method  $\Theta$  is changed from  $0^\circ$  to  $-90^\circ$  for the half sphere measurement. If the  $\Theta$  is changed from  $90^\circ$  to  $-90^\circ$  a full sphere measurement can be performed.

The distance  $d$  is given by clause B.2.3.5.

For measurements (e.g. TRP, see clause 5.6 or indirect emissions, see clause 5.7) angular steps for  $\Theta$  and  $\Phi$  shall be specified in the related standard. If no value for angular steps for the increase of  $\Theta$  and  $\Phi$  is provided in the related standard, then the value of  $15^\circ$  shall be used.

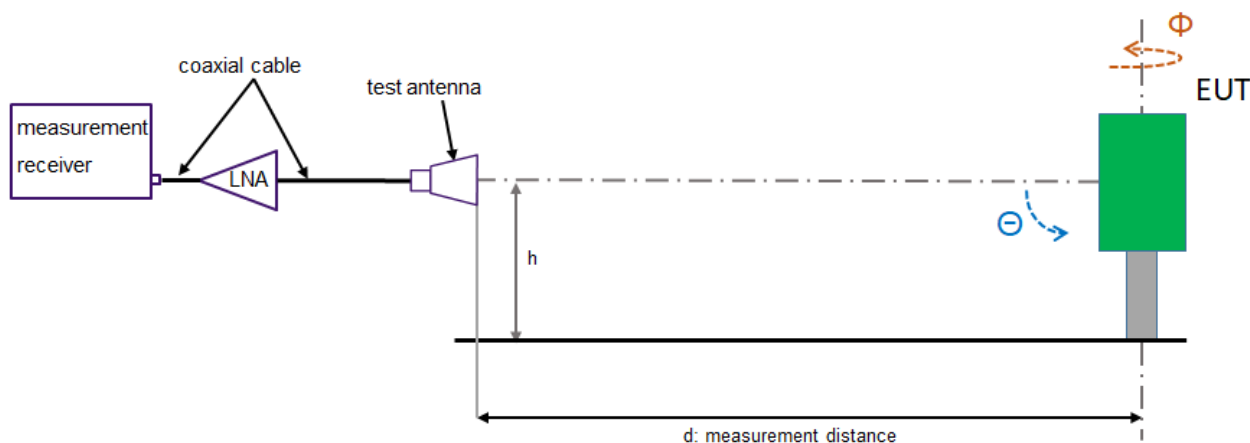

**Figure B.9: Spherical scan setup with rotation and tilt of the EUT**

NOTE: In this setup (see figure B.9), other relationships of the angles to the EUT is possible. For example: The  $\phi$  axis may be a vertical axis fixed to the turntable, yet passing through the EUT, while the angle  $\theta$  is about an axis fixed to the EUT. This configuration is valid as it ensures a full spherical measurement.

#### B.4.1.4.2 Calibrated Setup

The measurement receiver, test antenna and all associated equipment (e.g. cables, filters, amplifiers, etc.) shall have been recently calibrated against known standards at all the frequencies on which measurements of the equipment are to be made. A suggested calibration method is given in clause B 2.5.2.

If an anechoic chamber with conductive ground plane is used, the ground shall be covered by absorbing material in the area of the direct ground reflection from the EUT to the test antenna.

The equipment shall be placed in an anechoic chamber (compare clauses B.2.2.2 and B.2.2.3), which allows the rotation and tilt of the EUT. The EUT shall be placed closest to the orientation of normal operation.

The test antenna shall be oriented initially for vertical polarization and shall be chosen to correspond to the frequency of the transmitter.

The output of the test antenna shall be connected to the spectrum analyser via whatever (fully characterized) equipment is required to render the signal measurable (e.g. amplifiers).

The transmitter shall be switched on, if possible, without modulation, and the spectrum analyser shall be tuned to the frequency of the transmitter under test.

The TX antenna shall be stepwise rotated and tilted that the sphere of interest is covered. The signal level shall be noted in each location.

After all locations have been reached, the measurement procedure shall be repeated for horizontal polarized test antenna orientation.

The maximum signal level detected by the spectrum analyser shall be determined and converted into the radiated power by application of the pre-determined calibration coefficients for the equipment configuration used.

#### B.4.1.4.3 Substitution Method

The equipment shall be placed in an anechoic chamber, which allows the rotation and tilt of the EUT. The EUT shall be placed closest to the orientation of normal operation.

The test antenna shall be oriented initially for vertical polarization and shall be chosen to correspond to the frequency of the transmitter.

The output of the test antenna shall be connected to the spectrum analyser.

The transmitter shall be switched on, if possible, without modulation, and the measuring receiver shall be tuned to the frequency of the transmitter under test.

The TX antenna shall be stepwise rotated and tilted that the sphere of interest is covered. The signal level shall be noted in each orientation.

After all locations have been reached, the maximum signal level and the orientation of the EUT shall be noted.

The transmitter shall be replaced by a substitution antenna as defined in clause B.2.5.3.

The substitution antenna shall be orientated for vertical polarization and should an adjustable dipole be used, the length of the substitution antenna shall be adjusted to correspond to the frequency of the transmitter. Should a non-adjustable, broadband antenna be used, such adjustment is unnecessary..

The substitution antenna shall be connected to a calibrated signal generator.

If necessary, the input attenuator setting of the spectrum analyser shall be adjusted in order to increase the sensitivity of the spectrum analyser.

If an anechoic chamber with a conductive ground plane is used:

- then the test antenna shall be raised and lowered through the specified range of height that the maximum signal level is received; or
- if the ground shall be covered by absorbing material in the area of the direct ground reflection from the EUT to the test antenna, then variation in the height of the test antenna is unnecessary.

The input signal to the substitution antenna shall be adjusted to the level that produces a level detected by the spectrum analyser, that is equal to the level noted while the transmitter radiated power was measured, corrected for the change of input attenuator setting of the spectrum analyser.

The input level to the substitution antenna shall be recorded as power level, corrected for any change of input attenuator setting of the spectrum analyser.

The measurement shall be repeated with the test antenna and the substitution antenna orientated for horizontal polarization.

The measure of the radiated power of the radio device is the larger of the two levels recorded at the input to the substitution antenna, corrected for gain of the substitution antenna if necessary.

#### B.4.1.5 Spherical Scan Other Methods

Other methods for spherical scans are allowed but it has to be ensured that the relevant sphere is fully covered. And again, the calibrated or substitution method shall be applied. The method for the scanning shall be defined in a reproducible manner in the related standard.

## Annex C (normative): Signal Repetition Time

### C.1 Definitions

- Burst duration  $T_{on}$ : a continuous radio emission, or sequence of emissions separated by intervals shorter than  $T_{dis}$ . It defines a time frame that is continuously repeated. Each time frame (length  $T_{on}$ ) consists of the same signal waveform. This ensures that the same mean power spectral density is measured independently of which one of the time frames is captured by the measurement instrument. Even if the captured time frame is shifted in time (what will happen for real measurements without synchronization) the same result will be measured.
- $T_{off}$ : time between two time frames of  $T_{on}$ .
- Signal repetition time  $T_{rep} = T_{on} + T_{off}$ .

### C.2 Signal Types

#### C.2.1 Pulsed signals

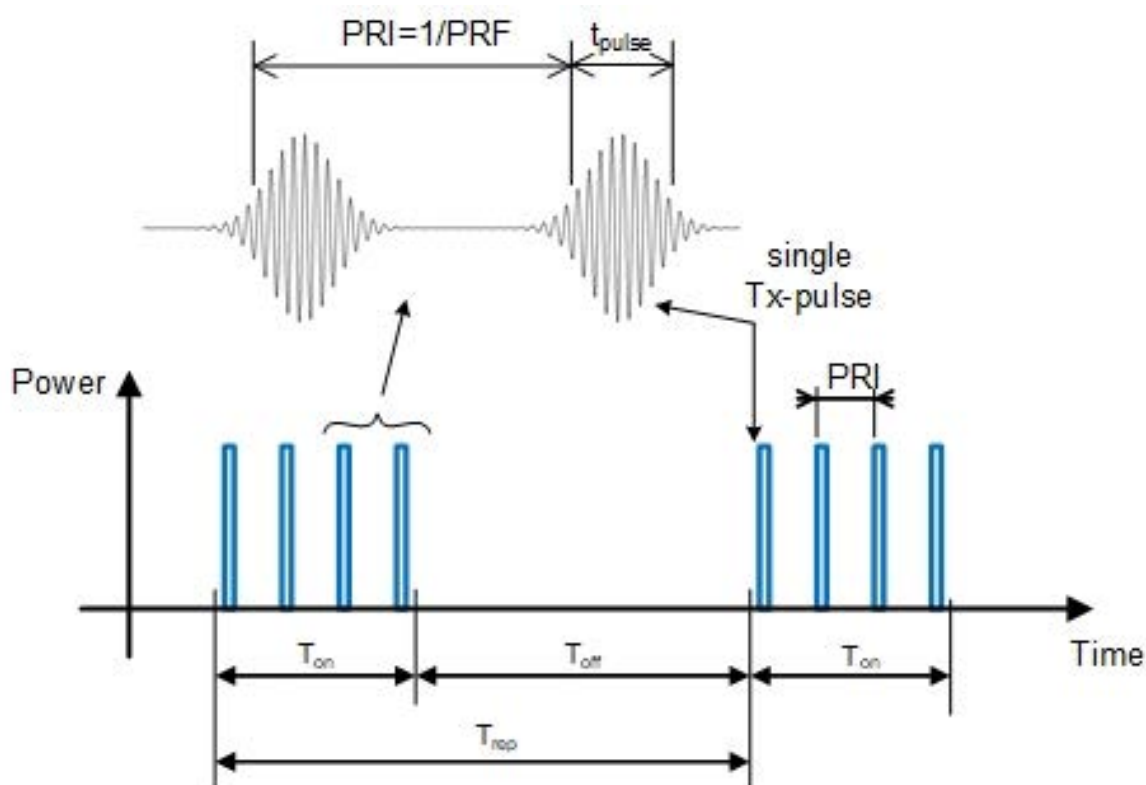

Figure C.1: Pulsed Signal

NOTE: For the case where the signal consists of a single, continuously repeated pulse, the transmitter is regarded as consistently repeating. As such,  $T_{off} = 0$ .

## C.2.2 FMCW signals, Stepped/Hopping Frequency Signals and Similar

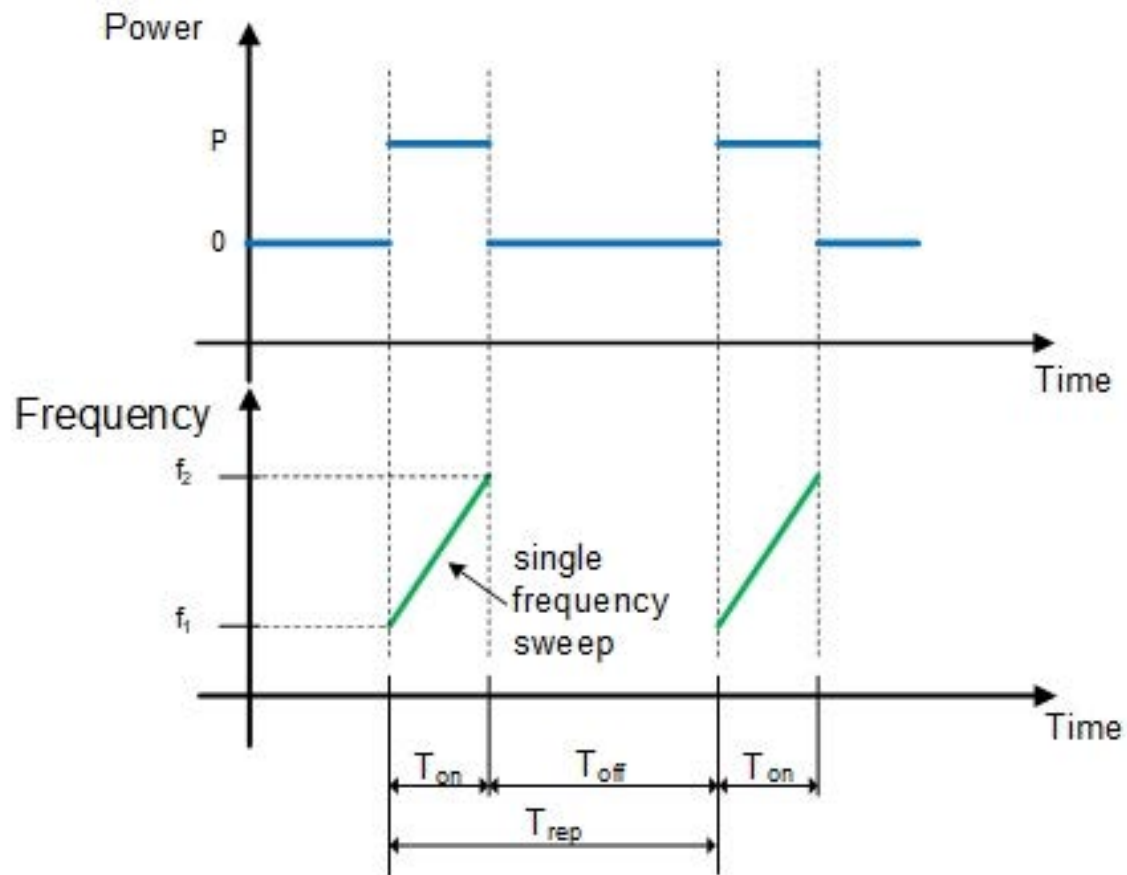

Figure C.2: FMCW signal 1, one single frequency sweep

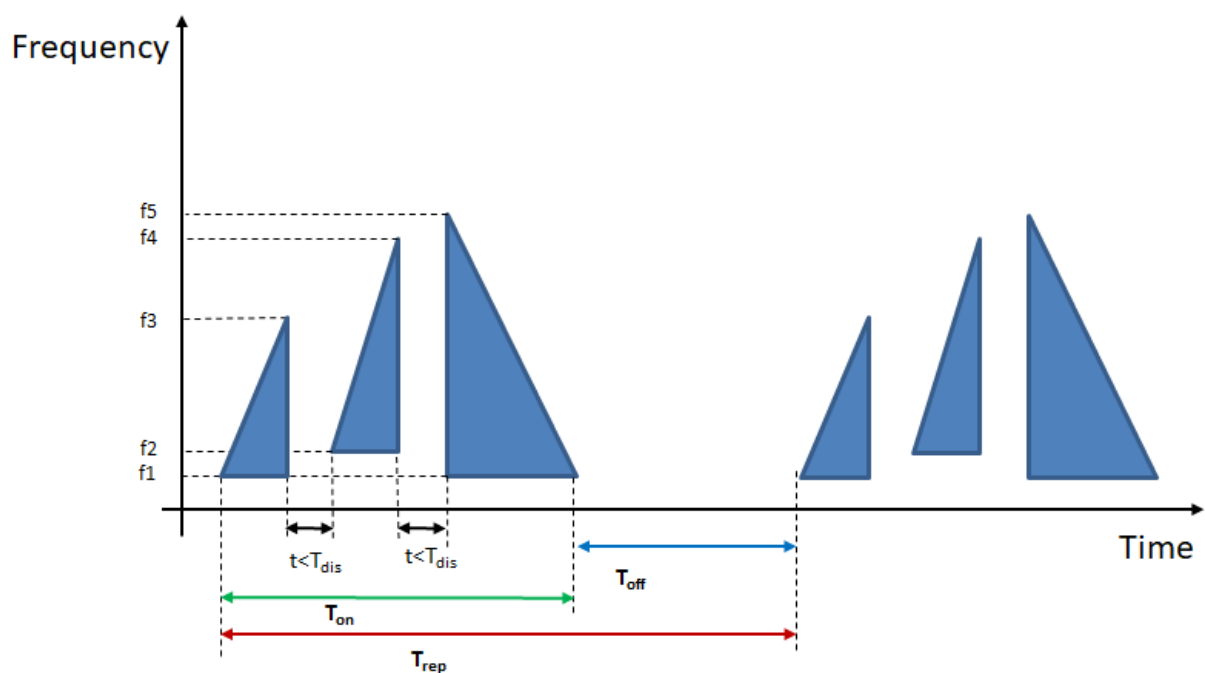

Figure C.3: FMCW signal 2, three frequency sweeps

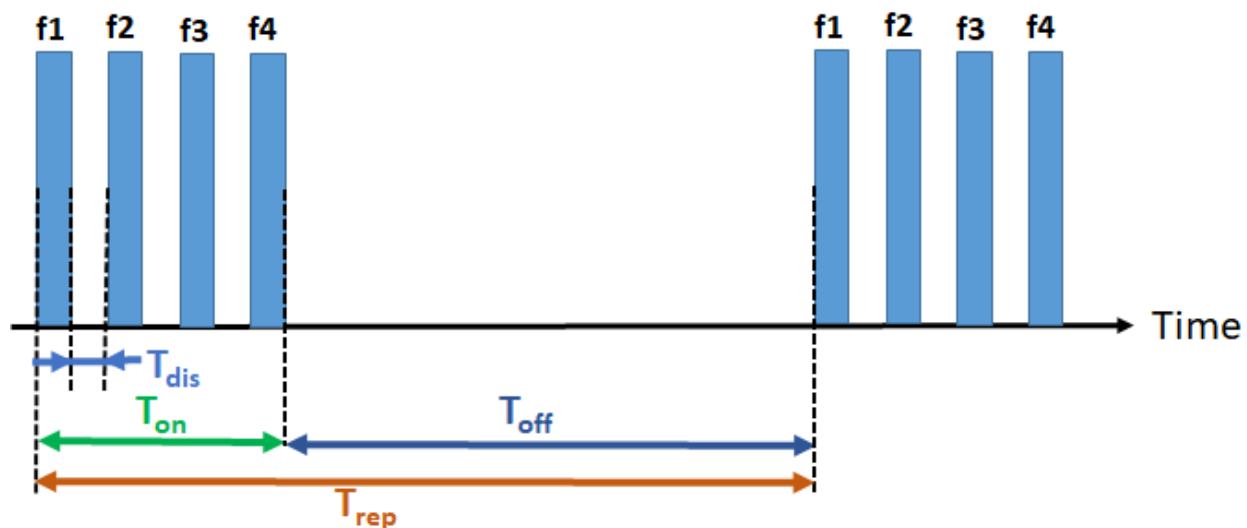

Figure C.4: Frequency-hopping signal

---

### C.3 Measurement procedure for time parameters

The Duty cycle measurement procedures in clause 5.11.2 can be used to assess the signal repetition time.

# Annex D (normative): All Emission Measurement

## D.1 General

This specific assessment procedure is for the (indirect) UWB emissions conformity assessment for EU. The regulated UWB emission level is lower than the power level of spurious emissions/EMC emissions from digital and analogue circuitry within the operating frequency range.

For such EUT, the UWB Radiated Power (RP) and TX Unwanted Emissions (TXUE) cannot be measured independently of the Other Emissions (OE) (e.g. narrow-band spurious emissions and the analogue or digital control circuitry emissions). That is because in some frequency ranges the regulated UWB RP emissions are very low power radio signals, comparable to the power limits of emissions from digital and analogue circuitry. If based on a measurement as described in this annex it can be assessed that an emission from the EUT is not the UWB RP emission limited in the relevant harmonised standards or it can clearly be assessed that it is impossible to differentiate between other emissions OE and the UWB RP emissions, the emission shall be considered as other emissions OE.

For such cases the RP, TXUE and OE from the EUT together are specified for such purpose of the test: as All Emissions (AE).

The limits for the OE emissions within the OFR (see table D.1 below) shall apply unless otherwise specified in the related standard.

**Table D.1: OE emissions limits within the OFR in line with ERC/REC 74-01 [i.9]**

Frequency range	Limit values for OE within the OFR
100 Hz (note 1) $\leq f < 10$ MHz	46,5 dB $\mu$ A/m at 100 Hz descending 3 dB/oct at 10 m
10 MHz $\leq f < 30$ MHz	-3,5 dB $\mu$ A/m at 10 m
87,5 MHz $\leq f \leq 118$ MHz	-54 dBm/100 kHz
174 MHz $\leq f \leq 230$ MHz	-54 dBm/100 kHz
470 MHz $\leq f \leq 694$ MHz	-54 dBm/100 kHz
otherwise in band 30 MHz $\leq f < 1\ 000$ MHz	-36 dBm/100 kHz
1 000 MHz $\leq f \leq f_H$ (note 2)	-30 dBm/1 MHz
NOTE 1: For the frequency range below 9 kHz: the limits are on voluntary basis, based on an EC request. ETSI proposed the limits to ECC to be implemented in ERC/REC 74-01 [i.9]. For the frequency range above 9 kHz: the limits are in line with ERC/REC 74-01 [i.9], annex 2.	
NOTE 2: For the OFR assessment, see clause 5.2 and related standard.	

NOTE: The limits for the OE are similar to the TXUE requirement outside the OFR (spurious emissions requirement for SRD which are comparable to EMC requirements for SRDs as well).

## D.2 First step

As a first step All Emissions (AE) of the EUT shall be measured as specified in the related standard (direct or indirect scenario). This measurement will include the related UWB Emission (within the OFR), the Transmitter Unwanted Emissions (TXUE) outside the OFR and Other Emissions (OE) (within and outside the OFR) of the EUT. These measurements shall be performed as specified in the related standard. The results shall be recorded.

Assessment of the emissions within the OFR:

Case 1: AE measurement fulfils the limits of mean e.i.r.p. spectral density and peak e.i.r.p. spectral density requirement for the UWB emission within the OFR, specified in the relevant standard. For this case no further assessment for the emission is necessary, see figure D.1.

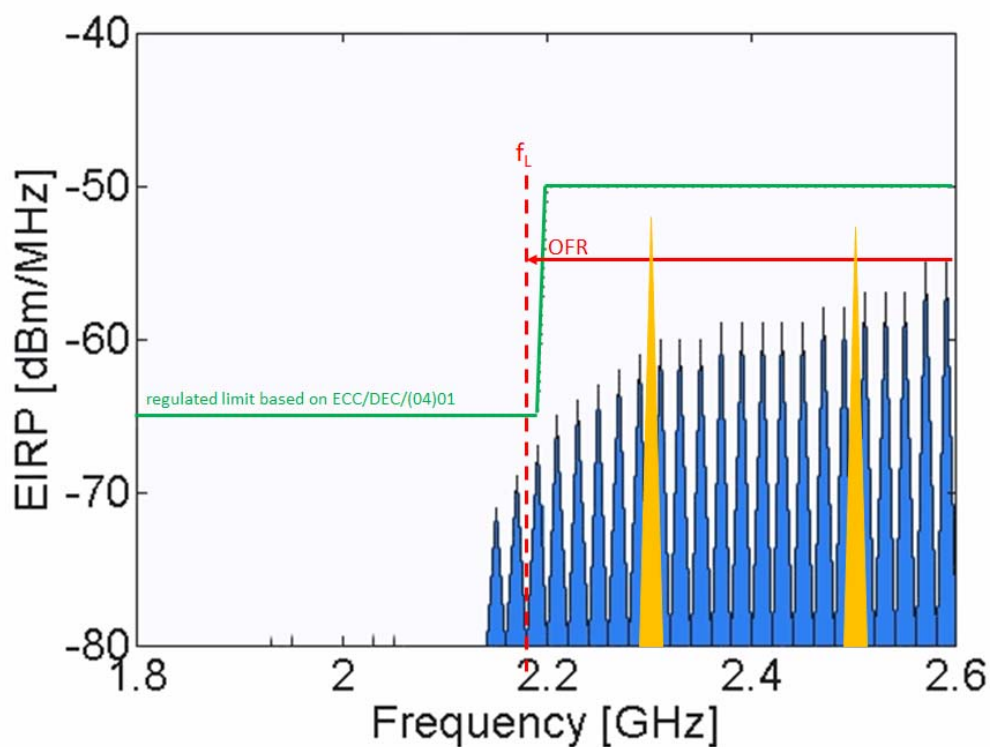

Figure D.1: Example for an AE measurement in the frequency range 1,8 GHz to 2,6 GHz for an EUT covered by ECC/DEC/(07)01 [i.4]

Case 2: If the recorded AE emission of the UWB device exceeds the corresponding UWB emission requirement (see related standard) within the OFR an additional assessment would be necessary (see figure D.2), second step, see clause D.3.

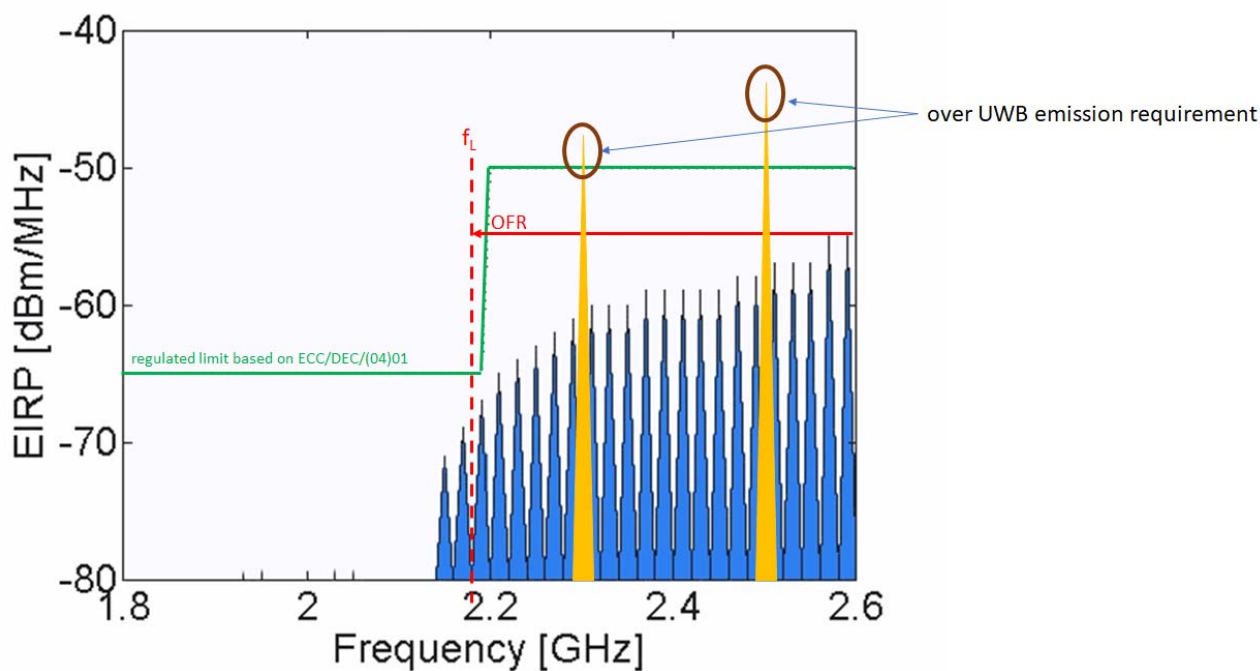

Figure D.2: Example for an AE measurement in the frequency range 1,8 GHz to 2,6 GHz for an EUT covered by ECC/DEC/(07)01 [i.4]



Assessment of the emissions outside OFR:

AE measurement shall fulfil the limits of the TXUE requirement within the related standard.

Case 1: Measurement result below the related TXUE limits (see in addition clause 5.5): test passed.

Case 2: Measurement results above the related TXUE limits (see in addition clause 5.5): test failed.

## D.3 Second step

The second step is mandatory if the recorded AE emission of the UWB device exceeds the corresponding UWB emission requirement within the operating frequency range (OFR, see clause 5.2), given in the relevant standard.

For the frequencies, where the All Emissions (AE) exceed the limits of the RP, the Other Emissions (OE) shall be measured by disabling the UWB transmitter or removing the antenna and terminating the transmitter. The rest of the UWB device shall be kept into the transmit mode.

Emissions that are present in OE as well as in AE with the similar amplitude within the measurement uncertainty are considered to be OE. This OE measurement shall be performed using the same measurement procedure than for step 1.

The principle of such case is illustrated in figure D.3.

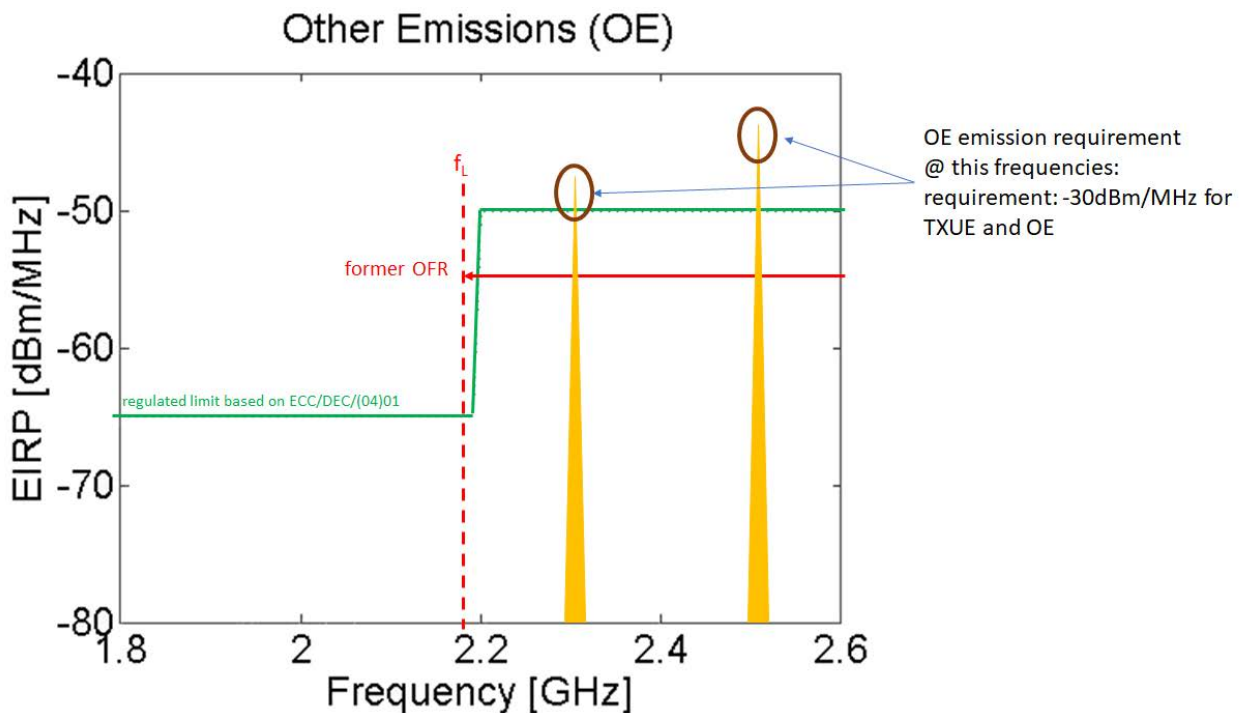

Figure D.3: Example for an AE measurement (only OE components) in the frequency range 1,8 GHz to 2,6 GHz for an EUT covered by ECC/DEC/(07)01 [i.4]

---

## Annex E (normative): Guidance for a pre-scan of EUT operating frequency range(s)

To verify the start and stop frequencies for the OFR measurements in clause 5.3.2, a pre-scan shall be performed as follows:

The spectrum analyser shall be connected to the test antenna (see clause B.2.2.5).

Spectrum analyser settings:

- Any RBW deemed suitable
- VBW equal to or greater than the RBW
- Start/stop frequency:
  - Around the start/stop frequencies of the specified operating frequency range(s) if known
  - Otherwise, sweep over intended frequency range of the related harmonised standard
- Detector mode: Peak
- Display mode: max hold
- Any suitable sweep time and number of points are accepted

A first measurement without the EUT transmissions present is performed as a reference measurement.

A second measurement is then performed with the EUT transmission present. A comparison between both will show the EUT operating frequency range.

The start and stop frequencies for the actual compliance measurements shall be at least as wide as the 10 dBc points found during this pre-scan.

## Annex F (informative): Measurement of peak e.i.r.p. and mean (average) e.i.r.p. of constant duty cycle wideband pulsed signals

### F.1 General

For the sake of simplicity, the following descriptions concern "classical" pulsed signals with a rectangular shape, a constant duty cycle and an unmodulated carrier signal.

With respect to these restrictions, the relationships between the key pulse parameters are well known:

- The pulse peak e.i.r.p. is given by the power of the carrier during the on period.
- The pulse peak e.i.r.p. and the pulse mean e.i.r.p. are connected via the duty cycle.
- The pulse spectrum is connected to the pulse peak e.i.r.p. via the "pulse desensitization factor" as described in the literature [i.30].
- For  $RBW \ll PRF$ , the mean and max PSD are identical.

### F.2 Exemplary measurement of pulse signals

In this example, it is shown how to measure a pulse train signal with constant duty cycle with different measurement methods and which results to expect. Therefore, a signal generator (pulse train signal source) and a spectrum analyser are connected, see figure F.1.

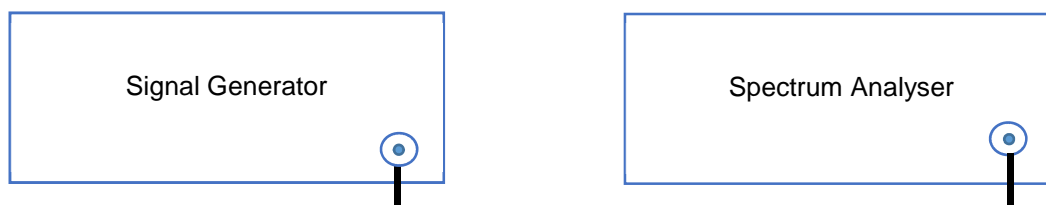

**Figure F.1: Measurement setup for method I/method II in clauses F.3.2 and F.3.3**

In a second setup, the Signal Generator is connected to a power meter, see figure F.2.

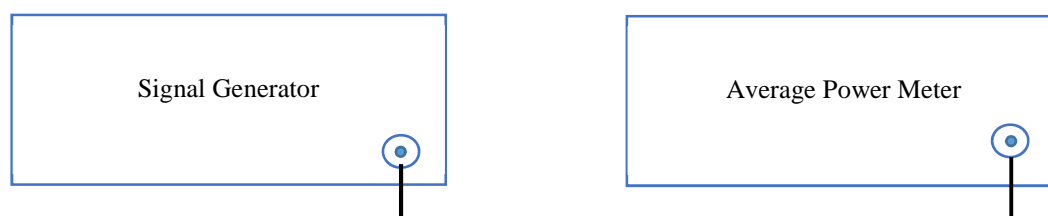

**Figure F.2: Measurement setup for method III in clause F.3.4**

The mean e.i.r.p. and peak e.i.r.p. are measured with three different methods and the results are shown.

Unless specified otherwise, the spectrum analyser RBW is chosen as  $RBW \ll PRF$ . This ensures that only one line of the pulse train's spectrum falls into the RBW at a time. The cable attenuation was measured as 1 dB and is compensated accordingly.

The signal generator is configured with the following pulse modulation settings, see table F.1.

**Table F.1: Pulse modulation settings**

Parameter	Value
Centre frequency, $f_c$	5,5 GHz
Power P	-20 dBm
Pulse width, $T_{on}$	250 ns
Operating frequency range, OFR	4 MHz
Pulse repetition interval, PRI	2,5 $\mu$ s
Pulse repetition frequency, PRF	400 kHz
Duty cycle [%]	10 %
Duty cycle [dB]	10 dB
Duty cycle <sup>2</sup> [dB]	20 dB

The expected measurement results based on figure F.1 are shown in table F.2.

**Table F.2: Expected measurement values**

Parameter	Reference	Value
Peak e.i.r.p.	= Signal generator level	-20 dBm
Mean e.i.r.p.	= Peak e.i.r.p.* Duty cycle	-30 dBm
Mean PSD at $f_c$	= Peak e.i.r.p.* Duty cycle <sup>2</sup>	-40 dBm
Max PSD at $f_c$	=  Mean PSD at $f_c$   <sup>2</sup>	-40 dBm
NOTE: Max PSD: Mean e.i.r.p. Spectral Density, see clause 5.3.2.		

## F.3 Mean e.i.r.p. measurements

### F.3.1 General

This clause explains and describes three methods to measure mean e.i.r.p. of a pulse signal with constant duty cycle. Two of these methods use a spectrum analyser (clauses F.3.2 and F.3.3), one uses a power meter (see clause F.3.4).

### F.3.2 Method I: Zero span mode

The following settings for the spectrum analyser in figure F.1 were used:

- RBW = 10 MHz
- VBW = 10 MHz
- RMS detector
- Zero span mode
- Number of points = 1 001
- Sweep time (SWT) = PRI  $\times$  Number of points  $\rightarrow$  SWT = 2,5  $\mu$ s  $\times$  1 001  $\approx$  2,5 ms

The measurement result is shown in figure F.3. The measured mean e.i.r.p. is -30,39 dBm.

NOTE: The SWT has to be set to PRI  $\times$  number of points in order to measure the mean e.i.r.p. correctly.

Choosing the SWT in this manner ensures that the RMS detector averages the video signal over exactly one PRI.

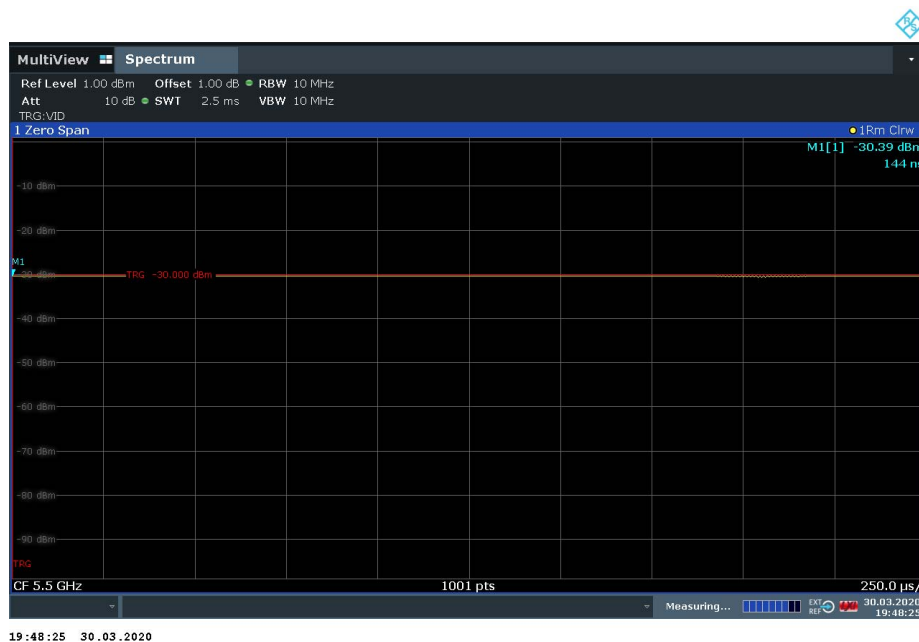

Figure F.3: Measurement result, Mean e.i.r.p.

This method requires the RBW to be wider than the pulse bandwidth. Consequently, for UWB pulses this method is in general not suitable.

### F.3.3 Method II: Channel power measurement

Settings for measurement setup of figure F.1:

- Channel power function
- RMS detector
- Channel bandwidth = 40 MHz

As shown in figure F.4 the channel power measurement estimates the mean e.i.r.p. to be -29,93 dBm.

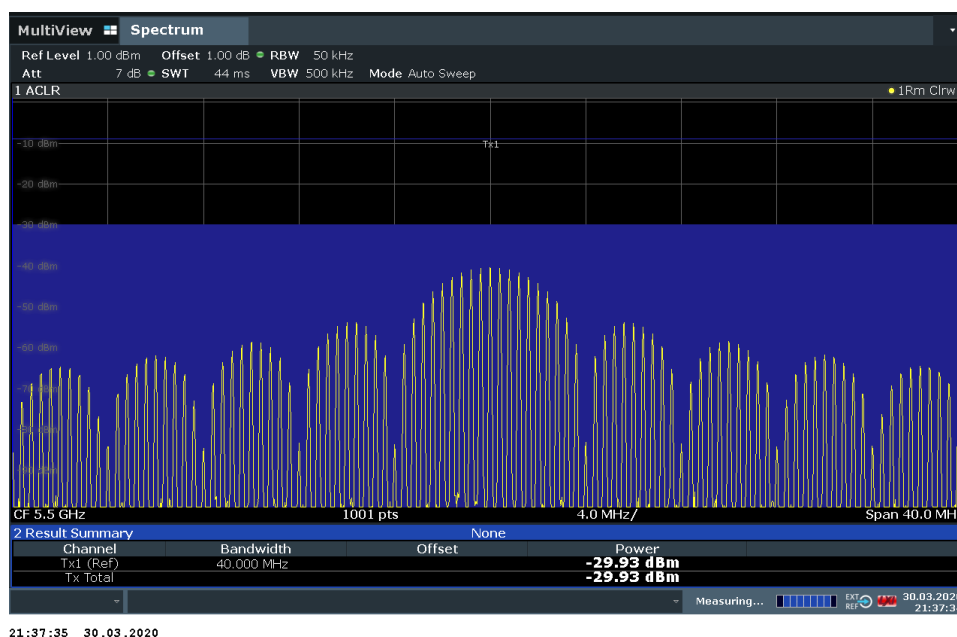

Figure F.4: Measurement results, channel power

## F.3.4 Method III: Average power meters

Table F.3 compares the results of Method I (clause F.3.2) and Method II (clause F.3.3) with two types of average power meters (measurement setup according to figure F.2). There are diode based and thermal based average power meters available.

**Table F.3: Comparison of mean e.i.r.p. measurement methods**

Approach	Mean e.i.r.p.	Main drawback
Theory	-30 dBm	
Average power meter - diode based	-30,9 dBm	Depends on modulation, not frequency selective
Average power meter - thermal	-29,79 dBm (note)	Low dynamic range, not frequency selective
Spectrum analyser - zero span	-30,39 dBm	Narrow band, accuracy
Spectrum analyser - channel power	-29,93 dBm	Accuracy
NOTE: Close to the sensor's dynamic range limit.		

## F.4 Peak e.i.r.p. measurements

### F.4.1 General

This clause describes and shows an example how to measure the Peak e.i.r.p. of the signal generator in setup shown in figure F.1. Obtaining the peak e.i.r.p. can be achieved in two different ways. One approach using a direct measurement and secondly by applying correction factors to other pulse parameters.

### F.4.2 Method I: Zero span mode - direct measurement

The direct measurement with a spectrum analyser (see figure F.1) is only possible where pulse signals have small bandwidths that fit into the RBW of the spectrum analyser. Consequently, this is not possible for most UWB devices.

RBW and VBW have to be wide enough to be able to capture the envelope of the pulse (operating frequency range).

Requirement:  $RBW > OFR$

Settings:

- RBW = 10 MHz
- VBW = 10 MHz
- Peak detector
- Zero span mode

Figure F.5 shows the result of the peak e.i.r.p. measurement. The peak e.i.r.p. is measured as -19,92 dBm. Since the operating frequency range is 4 MHz and the RBW is 10 MHz, the pulse can be measured without additional corrections.

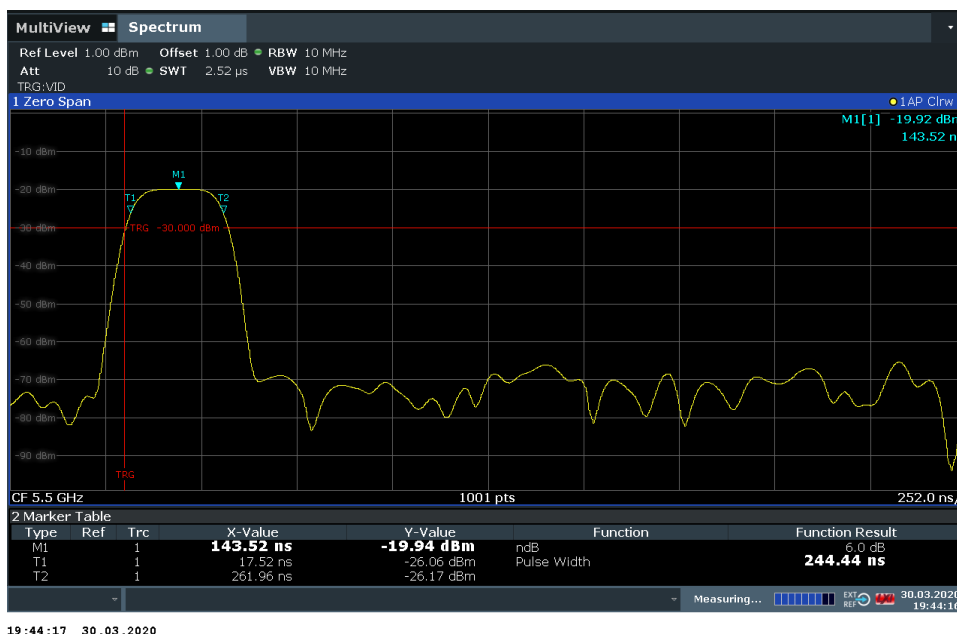

Figure F.5: Peak e.i.r.p. measurement with direct measurement where RBW > OFR

### F.4.3 Method II: Peak e.i.r.p. calculation

There are two ways to calculate the peak e.i.r.p. One way is to use the duty cycle and the mean e.i.r.p. according to formula (F.1).

$$Peak\ e.i.r.p = \frac{Mean\ e.i.r.p}{Duty\ cycle} \tag{F.1}$$

In this example the *Duty cycle* is 10 % (= 0,1 → - 10 dB) which yields to:

$$Peak\ e.i.r.p\ [dBm] = -30\ dBm - (-10\ dB) = -20\ dBm$$

For the different measurement approaches of the mean e.i.r.p., the following results for the peak e.i.r.p. are obtained.

Table F.4: Comparison of peak e.i.r.p. for different measurement approaches

Approach	Mean e.i.r.p.	Peak e.i.r.p.
Theory	-30 dBm	-20 dBm
Average power meter - diode based	-30,9 dBm	-20,9 dBm
Average power meter - thermal	-29,79 dBm (see note)	-19,7 dBm
Spectrum analyser - zero span	-30,38 dBm	-20,38 dBm
Spectrum analyser - channel power	-29,93 dBm	-19,93 dBm
NOTE: Close to the sensor's dynamic range limit.		

Alternatively, the peak e. i. r. p. can be calculated from the Max or Mean PSD via the pulse desensitization factor. This is only possible if the Fourier transform of the pulsed signal is known analytically. The pulse shape has to be known as a consequence.

$$Peak\ e.i.r.p = \frac{Mean\ PSD\ at\ f_c\ (Carrier\ Power)}{Duty\ cycle^2}$$

In the exemplary case, this gives:

$$Peak\ e.i.r.p\ [dBm] = -40\ dBm + 20\ dB = -20\ dBm$$

**Table F 5: Comparison of peak e.i.r.p. for different measurement approaches**

Approach	Mean PSD at $f_c$	Peak e.i.r.p.
Theory	-40 dBm	-20 dBm
Spectrum analyser - Max PSD	-40,10 dBm	-20,10 dBm

Based on this example, if the pulse bandwidth is small, a peak power meter could also be used to measure the peak e.i.r.p. For UWB pulses this is typically not possible as peak power meters usually have a video bandwidth of less than 200 MHz. Pulse bandwidths greater than 1 GHz, however, are not uncommon in UWB applications.

Even if the peak power meter could rectify the UWB pulse correctly (and thus track the pulse's power envelope) the following video filter would average out the majority of the pulse envelope. The resulting power reading would most likely be far off from the true peak e.i.r.p. value and much closer to the mean e.i.r.p.

## F.5 Max and mean PSD

Figure F.6 shows the (positive) peak detector (trace 1) and RMS detector (trace 2) traces of the generated pulse signal. As can be seen, the max and mean PSD give almost identical results.

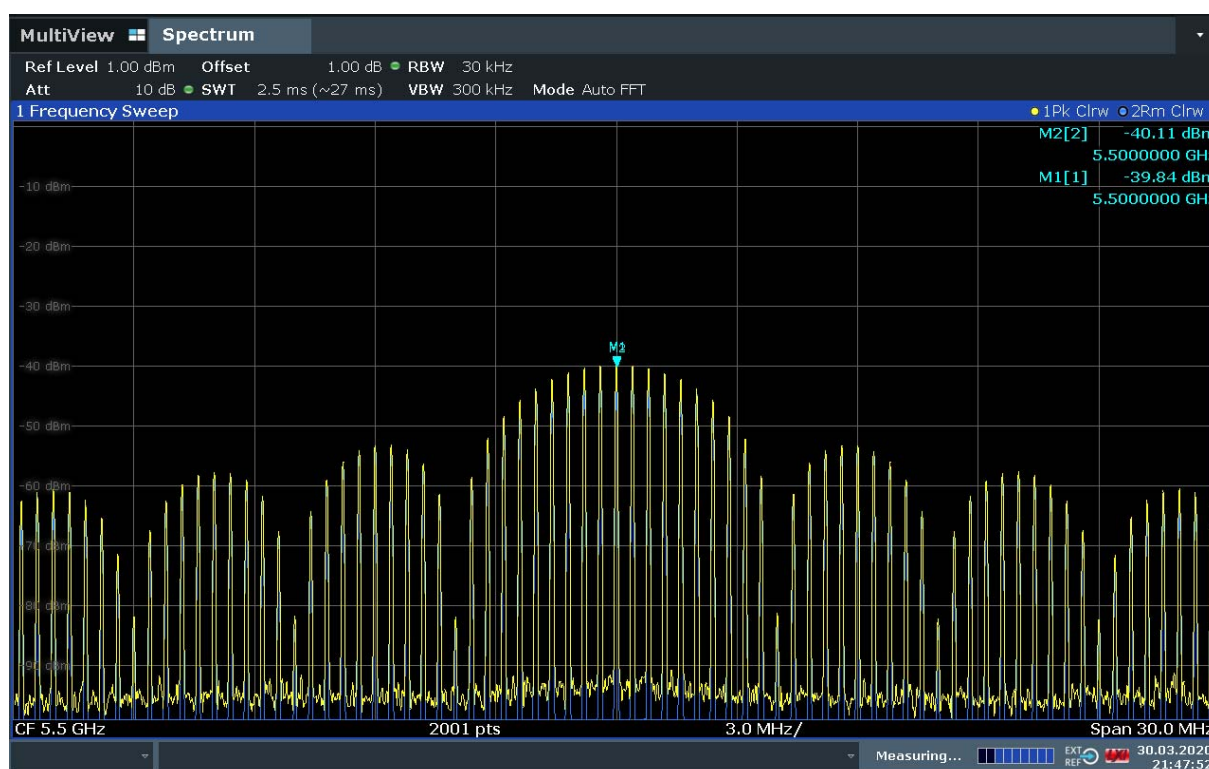

21:47:52 30.03.2020

**Figure F.6: Max and mean PSD of a pulse train line spectrum**

The reason for this behaviour is that in case of the  $RBW \ll PRF$ , only one line of the pulse spectrum fits in the spectrum analyser's RBW at a time. Consequently, the output of the envelop detector is constant as indicates in figure F.7.



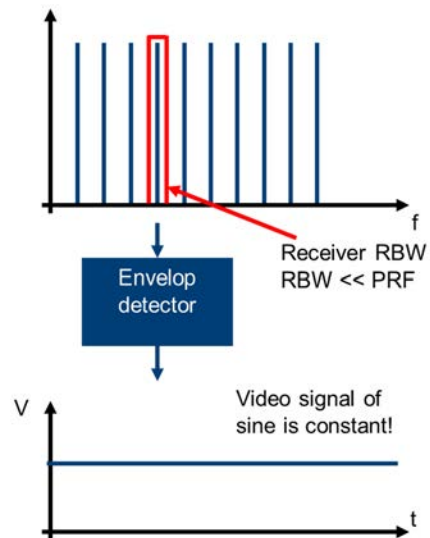

**Figure F.7: Pulse spectrum as seen by a spectrum analyser with an RBW <math>\ll</math> PRF**

A (positive) peak detector calculates the displayed pixel value from the highest available sample. An RMS detector calculates the displayed pixel value from the RMS of all available samples.

For a constant video signal, the peak and the RMS detector yield the same results.

---

## Annex G (informative): Change History

Date	Version	Information about changes
July 2020	1.2.0	<ul style="list-style-type: none"><li>• The previous version of the present document was ETSI EN 303 883 (V1.1.1). For the revision of ETSI EN 303 883 it was decided to split the transmitter and receiver parts into two different documents: ETSI EN 303 883-1 (V1.2.1) (the present document) for transmitter, and ETSI EN 303 883-2 (V1.2.1) for receiver.</li><li>• Addition of "mean power" measurement procedure.</li><li>• Changes.</li></ul>

## History

<b>Document history</b>		
V1.1.1	September 2016	Publication as ETSI EN 303 883
V1.2.0	July 2020	EN Approval Procedure AP 20201008: 2020-07-10 to 2020-10-08
V1.2.1	December 2020	Vote V 20210220: 2020-12-22 to 2021-02-22
V1.2.1	February 2021	Publication